

Lectures 6-7

Valence Shell Photoelectron Spectroscopy

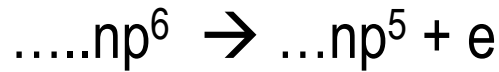

Exptl.^{a)}

I_ν (eV)

1	15.759	(${}^2P_{3/2}$)
2	15.937	(${}^2P_{1/2}$)

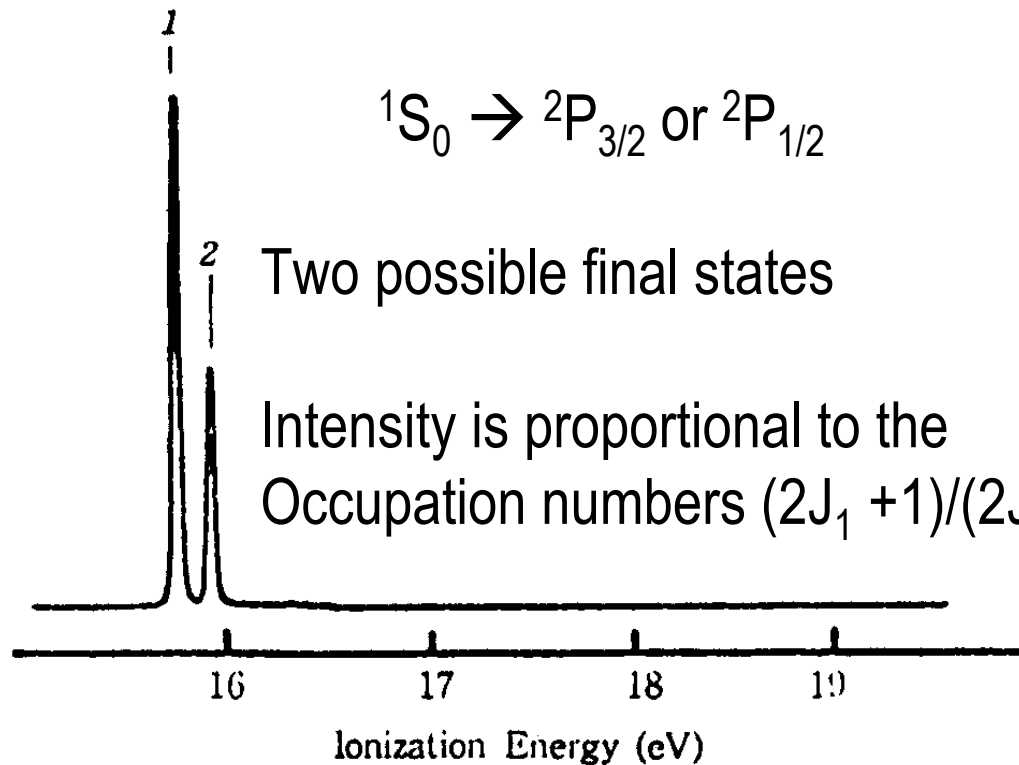

a) The spectrum: this work. The I_ν 's: Turner *et al.* (215). See also other works: Carlson and Jonas (54); Kemény *et al.* (126); and Branton *et al.* (37).

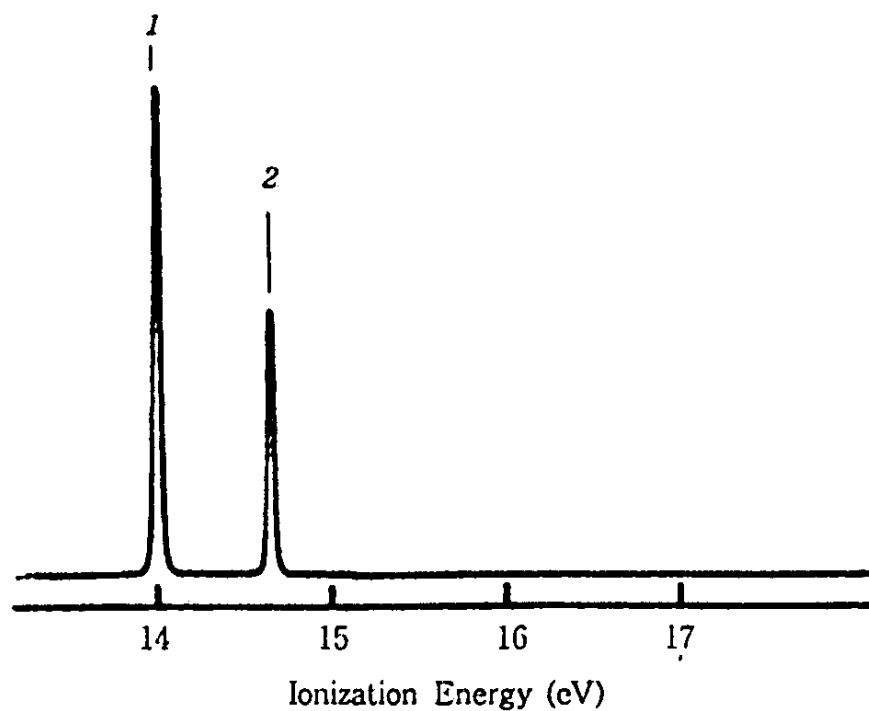

Exptl. ^{a)}		
I_v (eV)		
1	14.000	($^2F_{3/2}$)
2	14.665	($^2P_{1/2}$)

a) The spectrum: this work. The I_v 's: Turner *et al.* (215). See also other works: Kemeny *et al.* (126); and Carlson and Jonas (54).

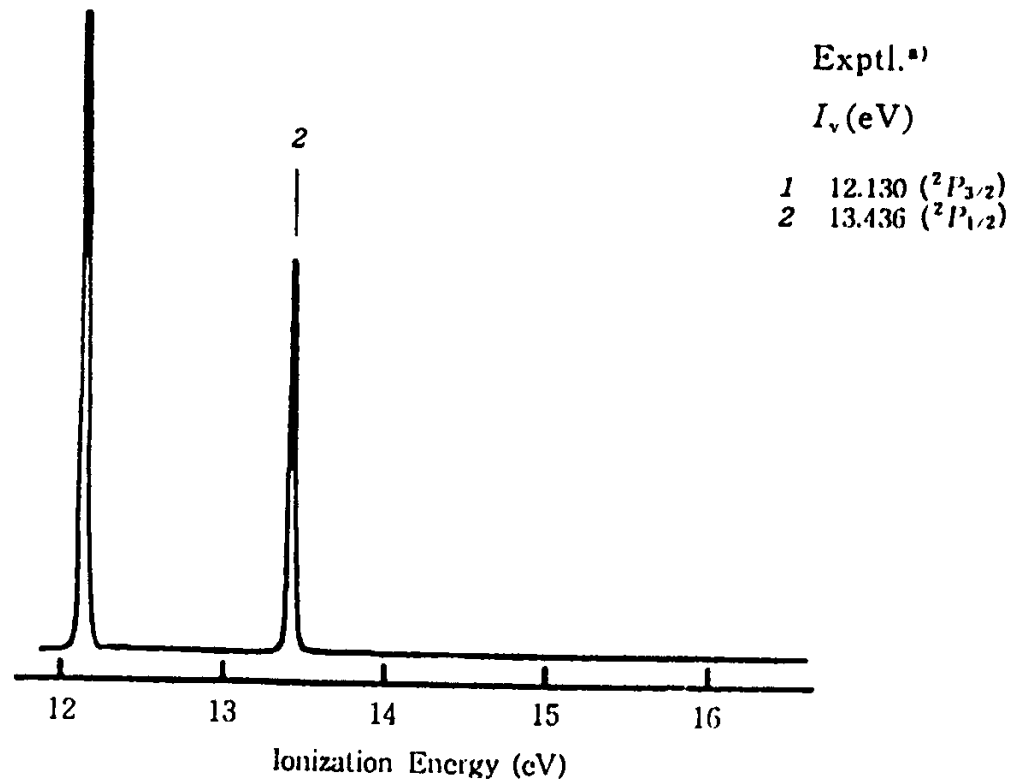

a) The spectrum : this work. The I_v 's : Turner *et al.* (215). See also other works : Kemeny *et al.* (126) and Carlson and Jonas (54).

Spin-orbit coupling constant,

$$\zeta = [(Z e^2 / 8\pi\epsilon_0 m_e^2 c^2) (Z/a_0)^3] / [n^3 l (l + 1/2) (l+1) hc]$$

$$= \alpha^2 R_\infty Z^4 / [n^3 l(l+1/2) (l + 1)];$$

proportional to Z^4

α - fine structure constant

$$e^2 / [4\pi\epsilon_0 \hbar c] = 1/137.03604$$

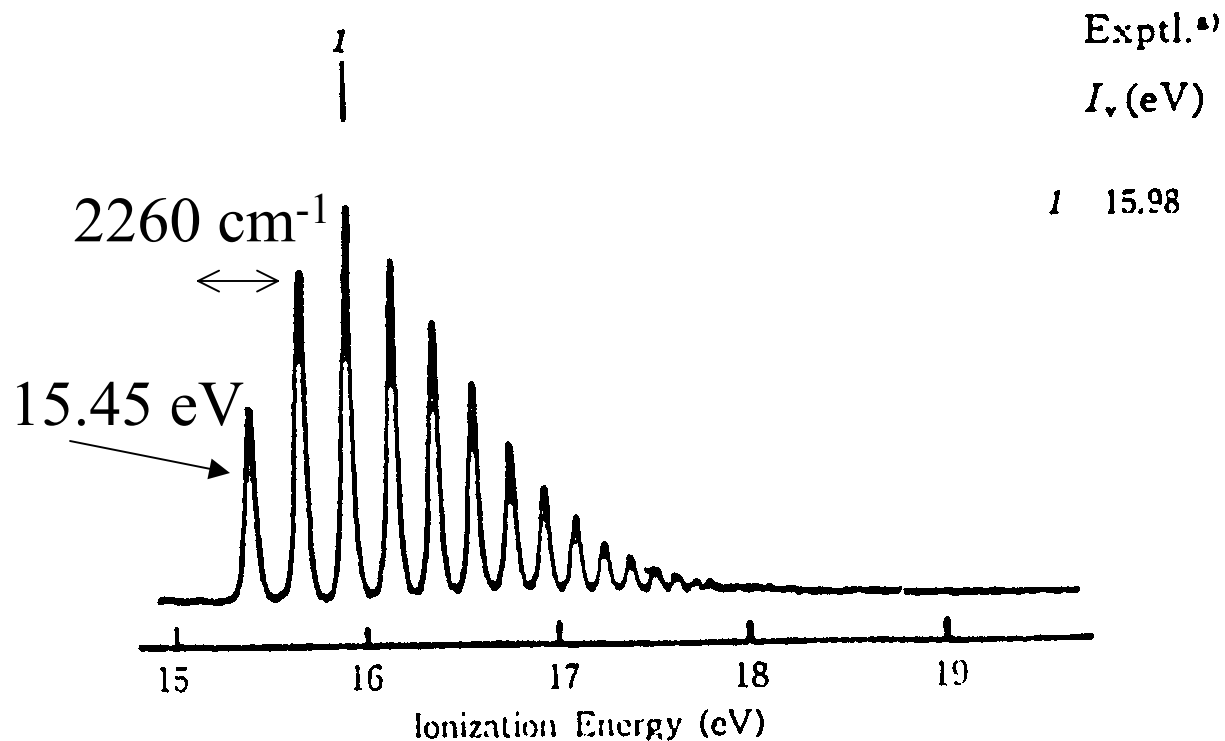

- a) The spectrum: this work. The I_v 's: Turner and May (215a). See also other works : Turner (214); Turner *et al.* (215); Åsbrink (3); Cornford *et al.* (67); Niehaus and Ruf (167); Shaw and Berry (204); Carlson and Jonas (54); Berkowitz and Spohr (23); and Lee and Rabalais (149).

Vibrational Structure

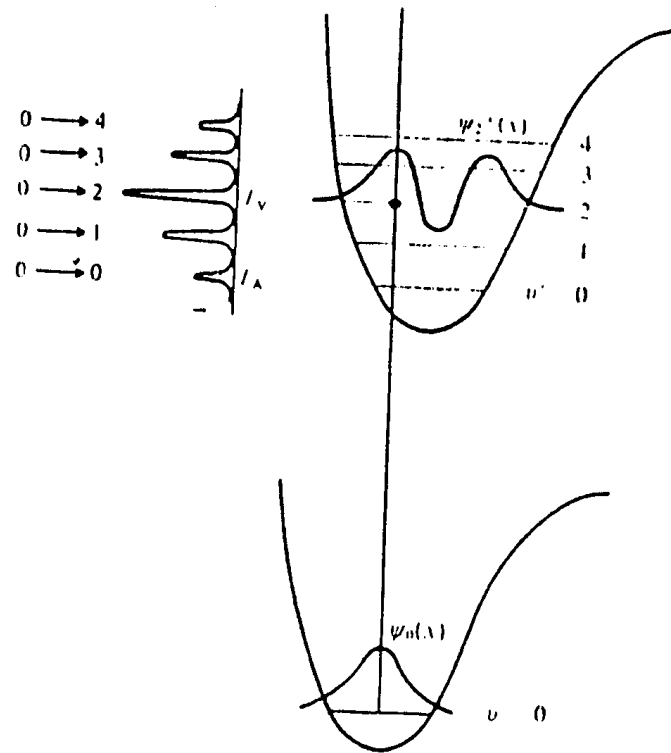

Figure 20.12 Potential energy curves for a molecule and one of its ionized states, illustrating the 'vertical' nature of the photoionization process and the production of the molecule-ion in different vibrational states.

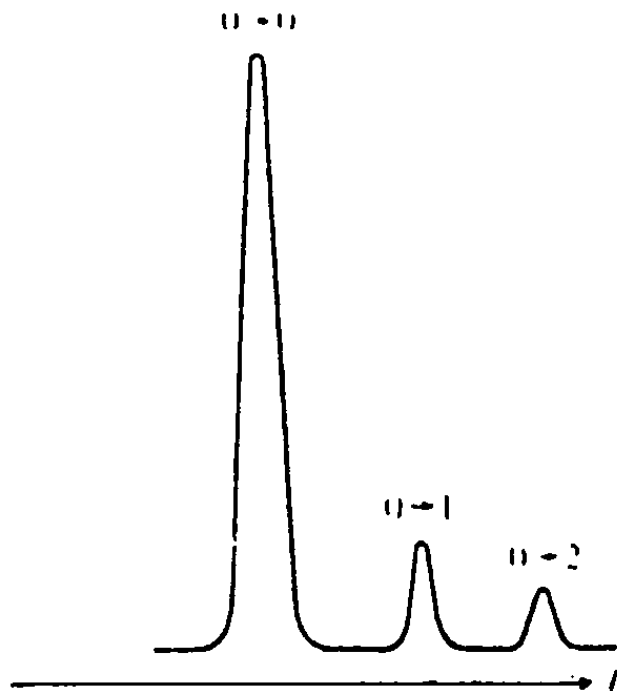

Figure 20.13 The form of the vibrational line structure of a PE band when photoionization occasions very little change of molecular dimensions

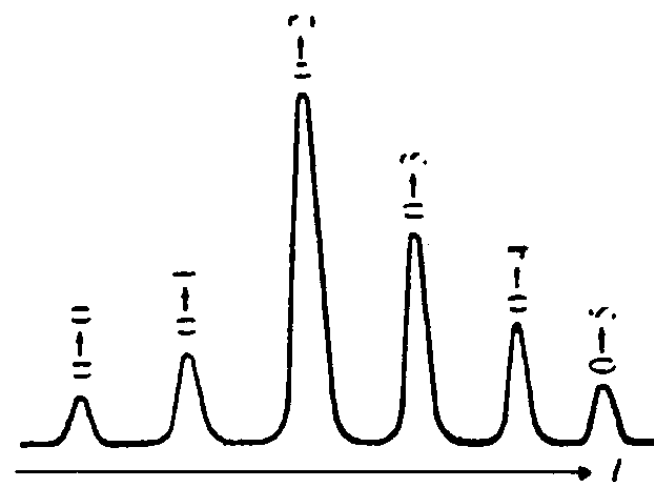
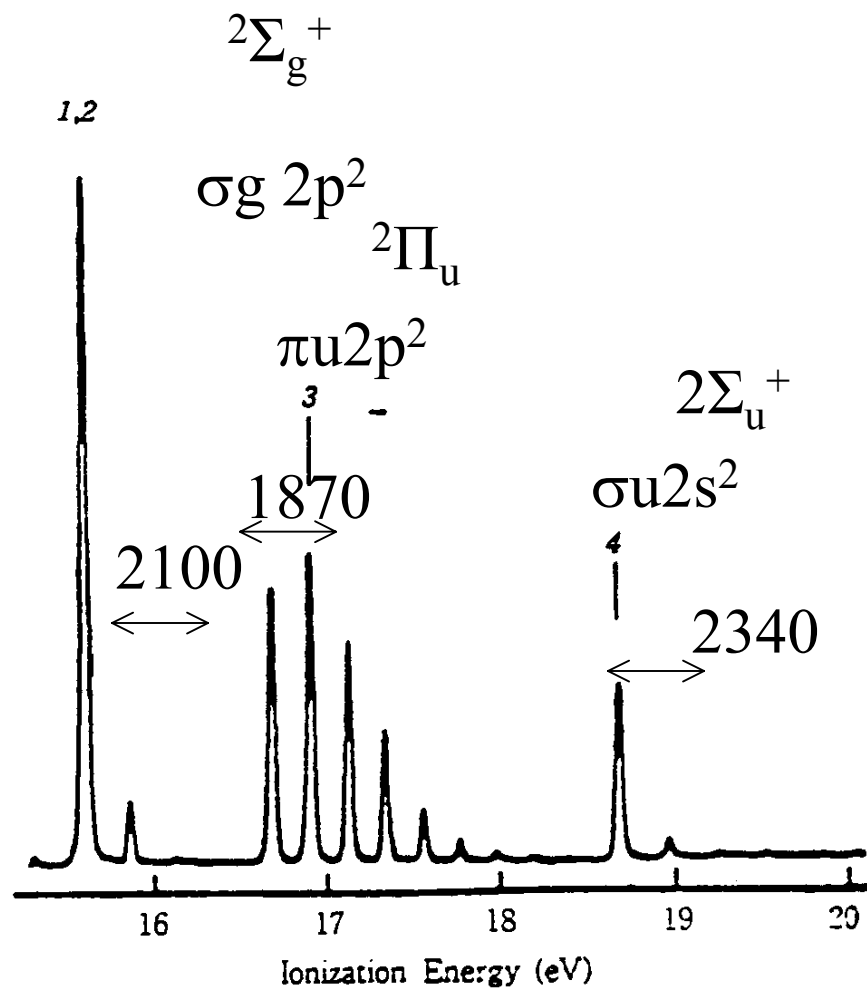

Figure 20.14 Typical vibrational line structure for a PE band when there is a significant change in molecular dimensions upon photoionization.

(7) N₂ Nitrogen



Adiabatic 15.57 16.69 18.75 eV

Franck – Condon Factor

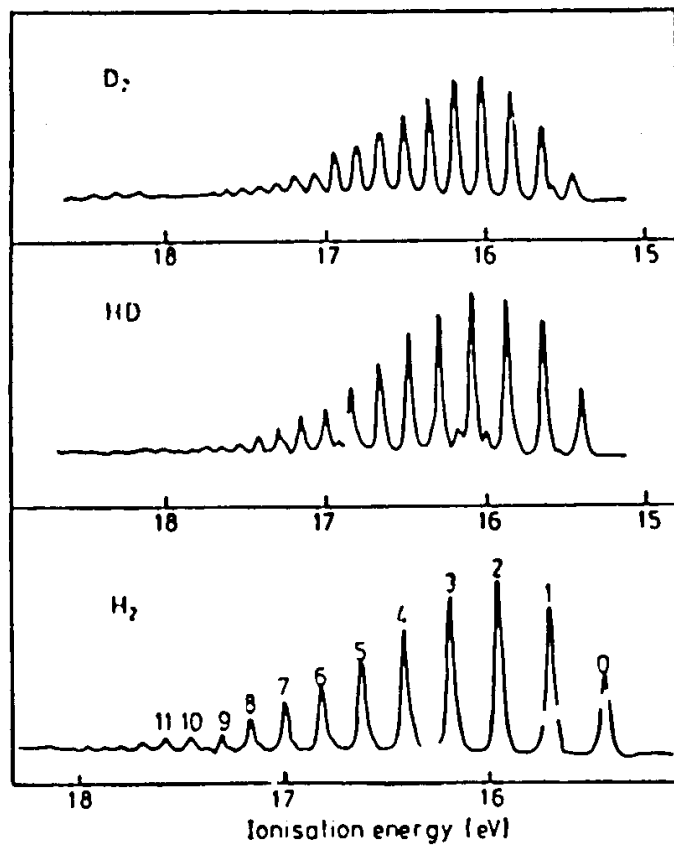

Figure 26.1. Photoelectron spectra of D_2 , HD and H_2 obtained using He resonance radiation. The numbers in the H_2 spectrum denote the vibrational quantum number of the ionised state (Berkowitz and Spahr 1973).

Dipole approximation, probability $\propto \langle \phi | er | \phi^+ \rangle^2$

$\phi = \Psi \Theta$ Born – oppenheimer approximation

$$\langle \phi | er | \phi^+ \rangle = \langle \Psi | er | \Psi^* \rangle \langle \Theta | \Theta \rangle$$

er is electronic operator, acts only on the electronic part of the wave function.

Franck – Condon factor $\langle \Theta | \Theta \rangle^2$

FC factors predict intensities accurately. Deficiencies due to neglect of rotations, neglect of polarisation of ion by photoelectron, deviation of neutral molecule from equilibrium geometry by zero point motion and failure of Born – Oppenheimer approximation

Table 26.1. Ionisation energies, experimental intensities and calculated Franck-Condon factors for the ionisation of H₂, HD and D₂ (Berkowitz and Spohr 1973, Gardner and Samson 1976)

Molecule	n(ion)	I(eV)	Experimental intensity		Franck-Condon factor (Gardner and Samson 1976)
			(Berkowitz and Spohr 1973)	(Gardner and Samson 1976)	
H ₂	0	15.4254	0.463	0.448	0.521
	1	15.6971	0.863	0.922	0.918
	2	15.9530	1.000	1.000	1.000
	3	16.1936	0.884	0.969	0.879
	4	16.4194	0.700	0.713	0.689
	5	16.6308	0.579	0.572	0.508
	6	16.8281	0.472	0.423	0.361
	7	17.0113	0.313	0.308	0.253
	8	17.1808	0.241	0.208	0.176
	9	17.3365	0.137	0.132	0.122
	10	17.4783		0.089	0.085
	11	17.6061		0.058	0.060
	12			0.039	0.042
	13			0.024	0.030
	14			0.015	0.021
15			0.005	0.014	
HD	0	15.444	0.300		0.402
	1	15.682	0.676		0.818
	2	15.907	1.000		1.000
	3	16.120	0.975		0.965
	4	16.329	0.963		0.816
	5	16.515	0.810		0.638
	6	16.710	0.634		0.475
	7	16.880	0.407		0.344
	8	17.040	0.264		0.245
	9	17.185	0.218		0.173
10	17.330	0.160		0.123	
D ₂	0	15.466	0.230		0.260
	1	15.664	0.538		0.648
	2	15.854	0.812		0.940
	3	16.032	0.950		1.048
	4	16.206	1.000		1.000
	5	16.371	0.928		0.864
	6	16.528	0.756		0.699
	7	16.680	0.624		0.541
	8	16.824	0.487		0.407
	9	16.962	0.342		0.300
10	17.087	0.270		0.219	

Vibrational Interval

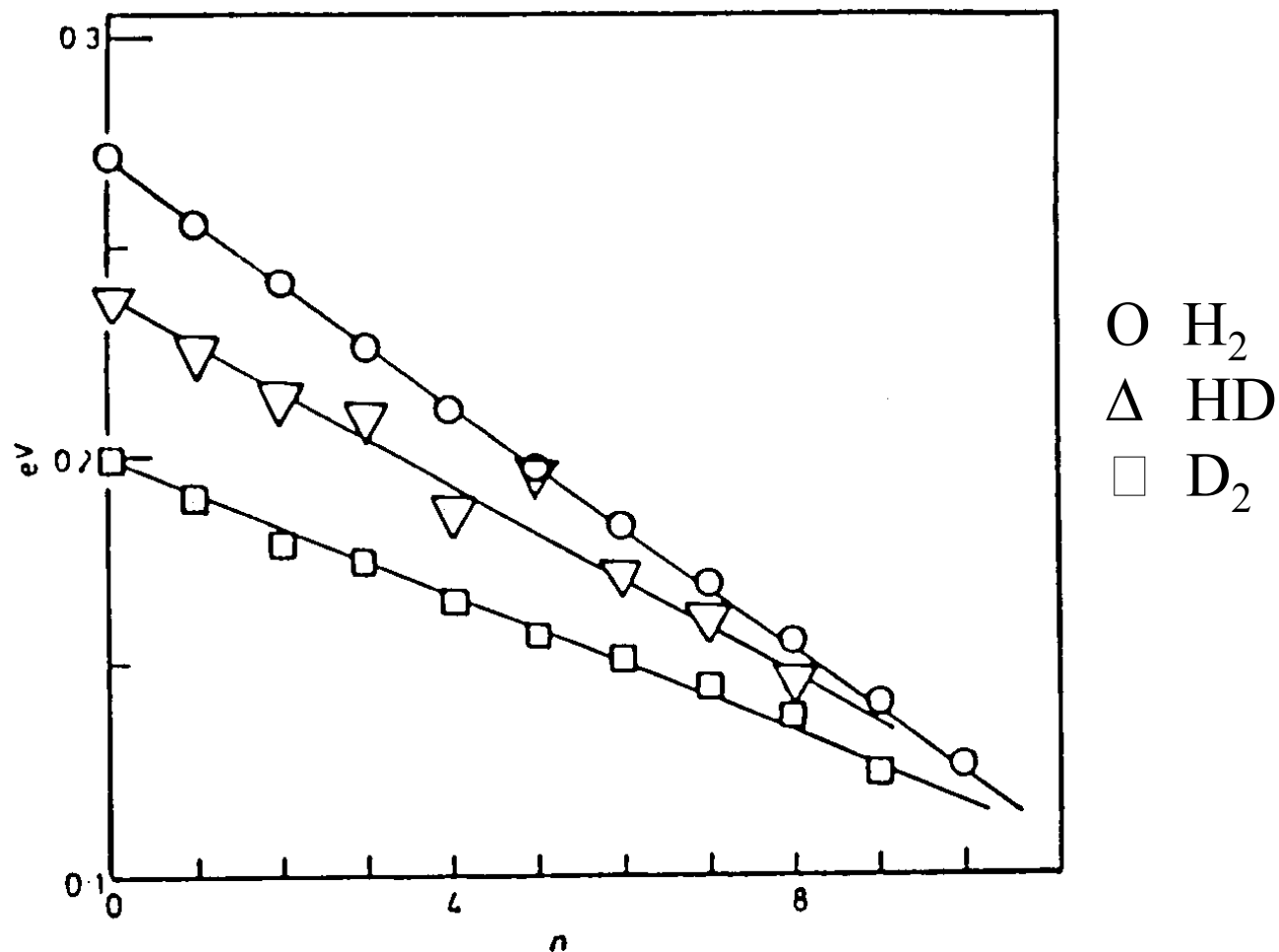

Figure 27.1. Plots of the vibrational interval against the vibrational quantum number, n , for the $^2\Sigma_g^+$ bands of H_2 , HD and D_2 . \circ H_2 ; ∇ HD ; \square D_2 .

For H_2^+ , $D = 2.648 \text{ eV}$

$$D = 12 \omega_0 n_D$$

For H_2^+ $n_D = 19$ and $\omega_0 = 0.2712$

$$\begin{aligned} D &= 1/2 \times 19 \times 0.2712 \\ &= 2.58 \text{ eV} \end{aligned}$$

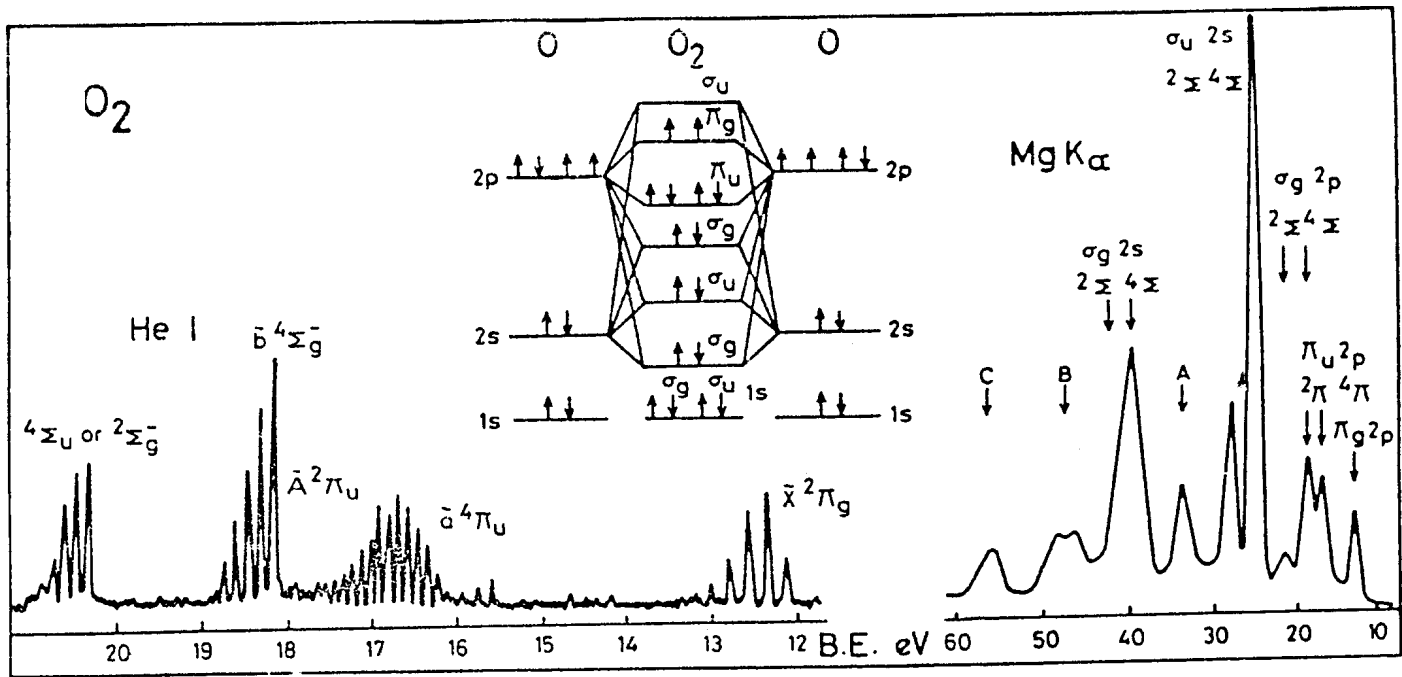

Fig. 4.2. Valence electron spectra of oxygen using HeI and Mg K α sources [4, 5].

Spin multiplicities

$$\pi_g \alpha p \rightarrow 2\pi$$

$$\pi_n \alpha p \rightarrow 2\pi, 4\pi$$

Energy loss shake up

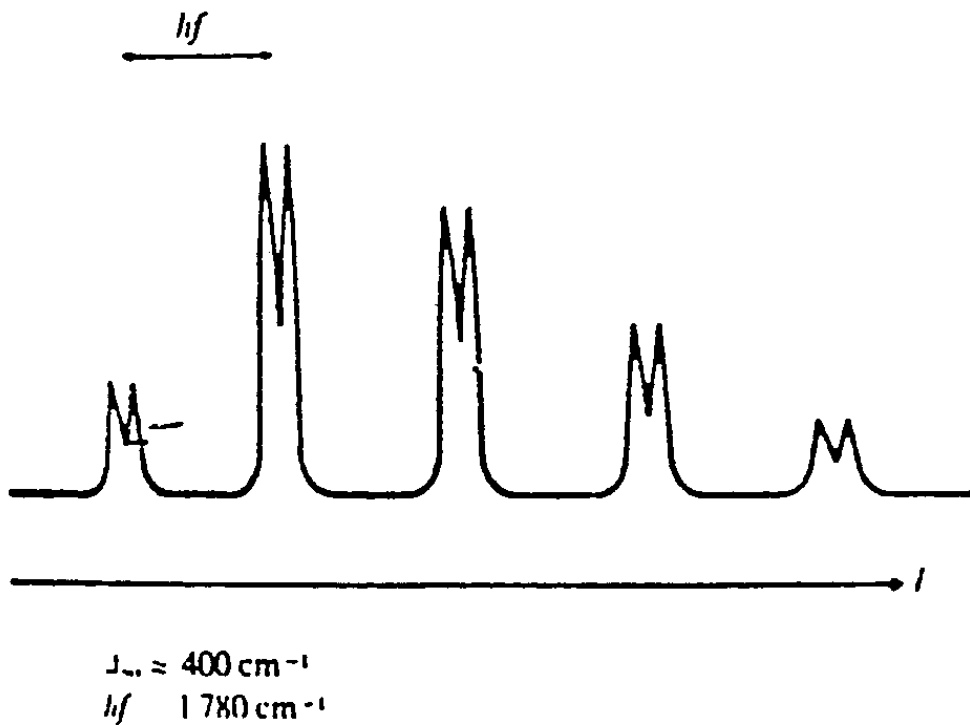
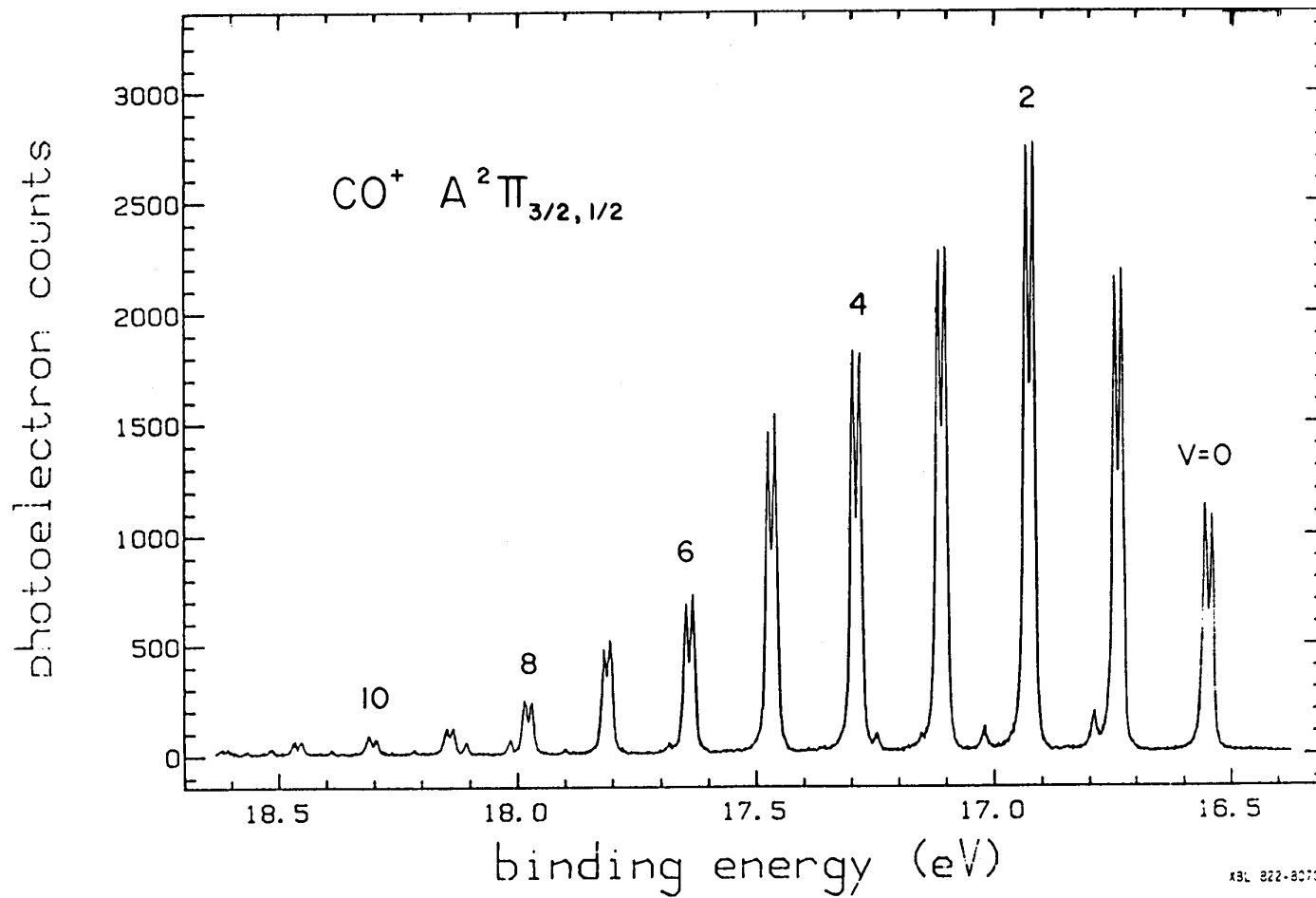

Figure 20.18 The first band in the PE spectrum of O_2 excited by Ne I ($h\nu = 16.85 \text{ eV}$) radiation. (The spectrum has been stripped of equivalent structure due to ionization by the less intense Ne I line having $h\nu = 16.67 \text{ eV}$.)



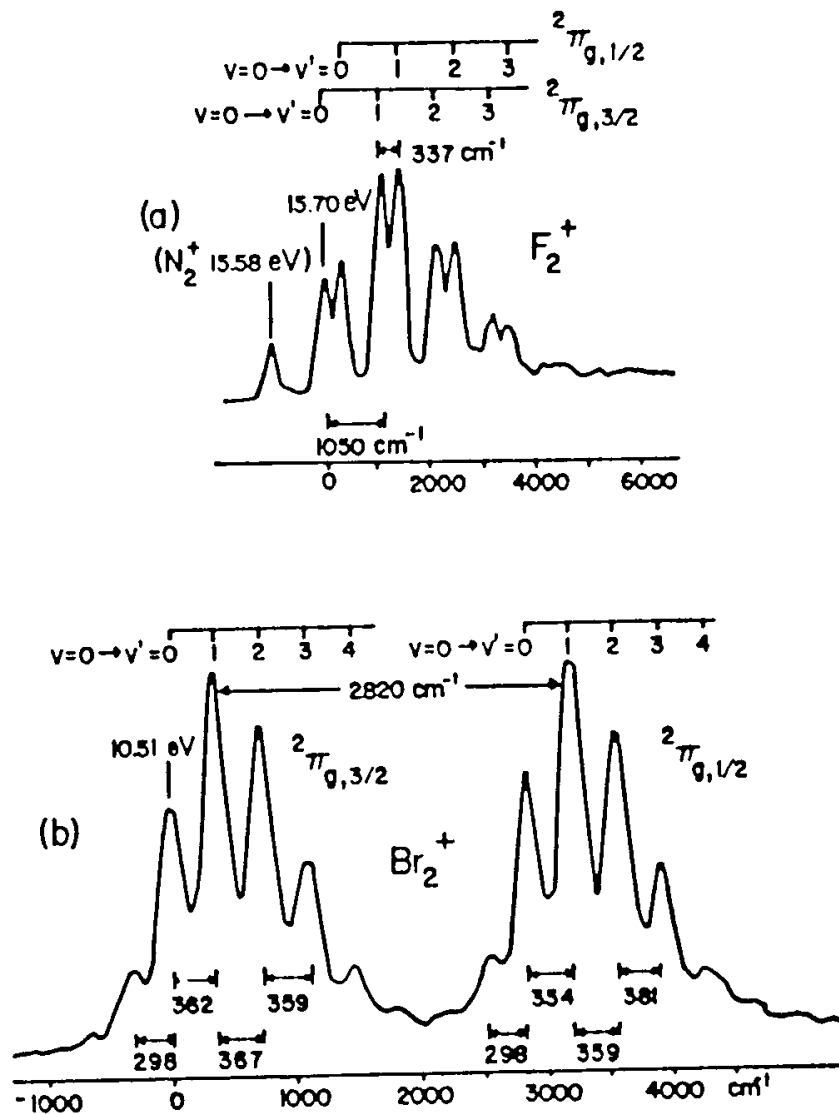

Fig. 5-18. He I photoelectron spectra of (a) F_2 and (b) Br_2 , showing fine structure of the lowest ionic states. From A.B. Conford, D.C. Frost, C.A. McDowell, J.L. Ragle, and I.A. Stenhouse, *J. Chem. Phys.*, 54, 2651 (1971).

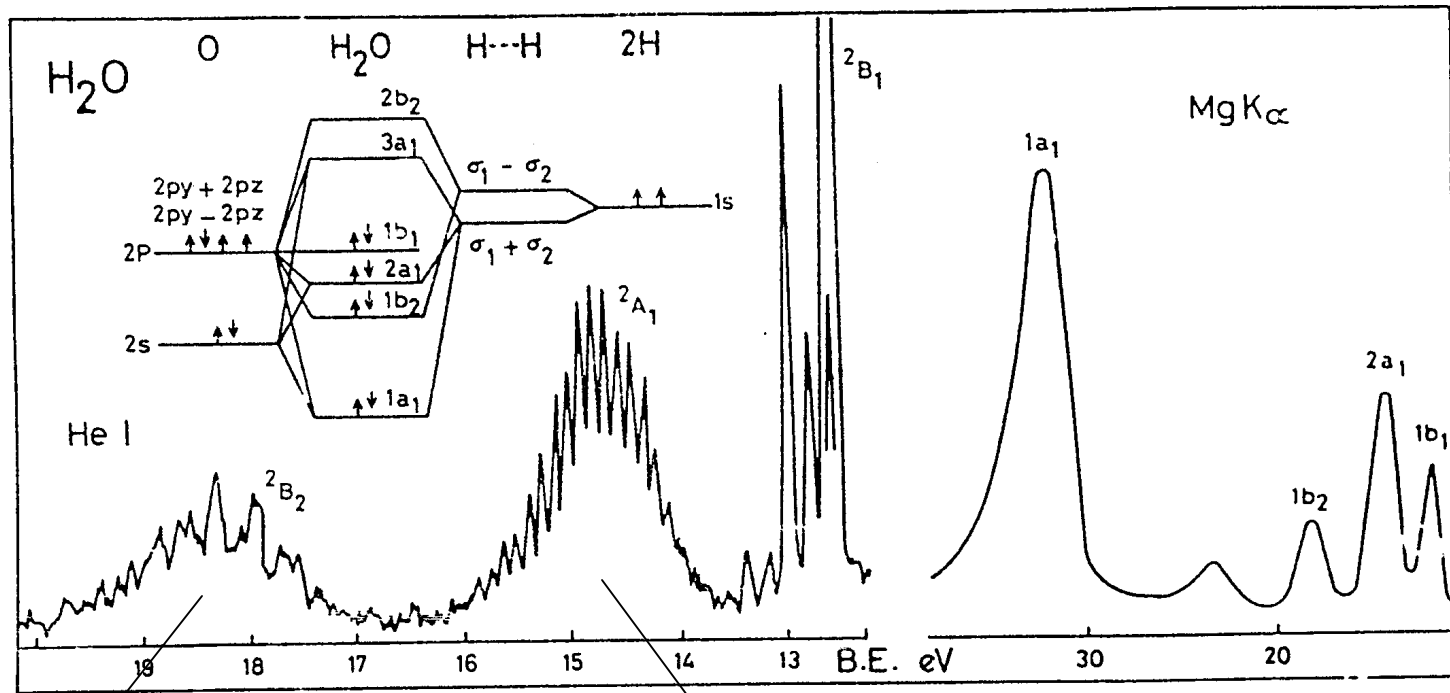

Fig. 4 3. Valence electron spectra of water using HeI and Mg $K\alpha$ sources [4, 5].

Life time

H – H anti bonding

ν_2 increases (bonding)

ν_1 decreases (stretching)

Bonding ν_2

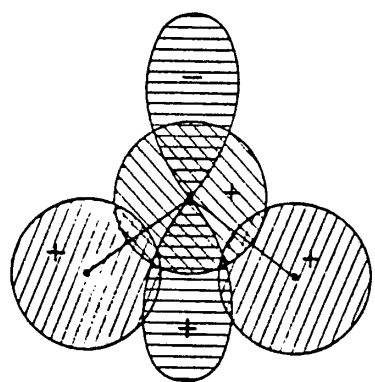
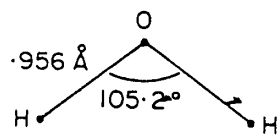

$\psi 3a_1$

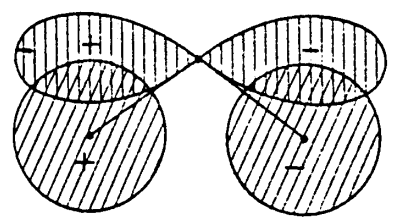

$\psi 1b_2$

Figure 4.33 The occupied orbitals of the water molecules illustrated in terms of their constituent atomic orbitals

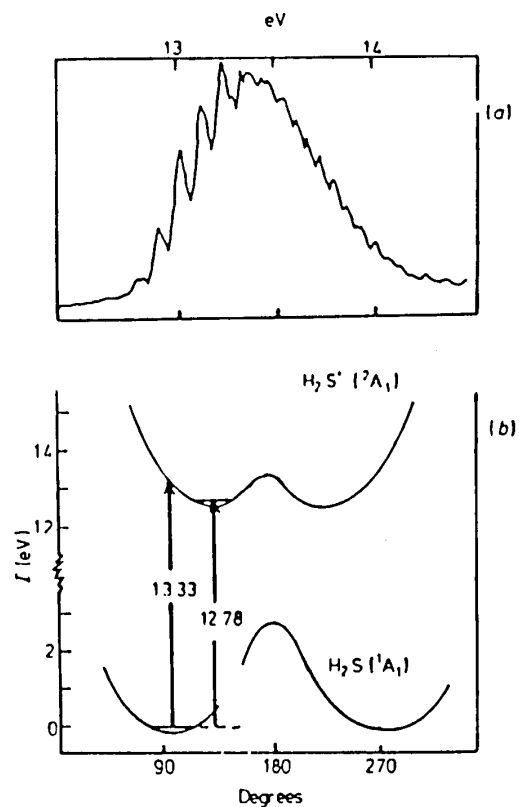

Figure 32.2. (a) The photoelectron spectrum of H_2S in the region of ionisation of the $3a_1$ electronic orbital (cf figure 17.2). The inversion barrier is surmounted at 13.3 eV, where a halving of the vibrational interval is seen (Potts and Price 1972). (b) Schematic potential energy plot of the ground state of H_2S and the $3a_1^{-1}$ state of H_2S' . The adiabatic and vertical ionisation energies are shown.

Vibrational Inversion

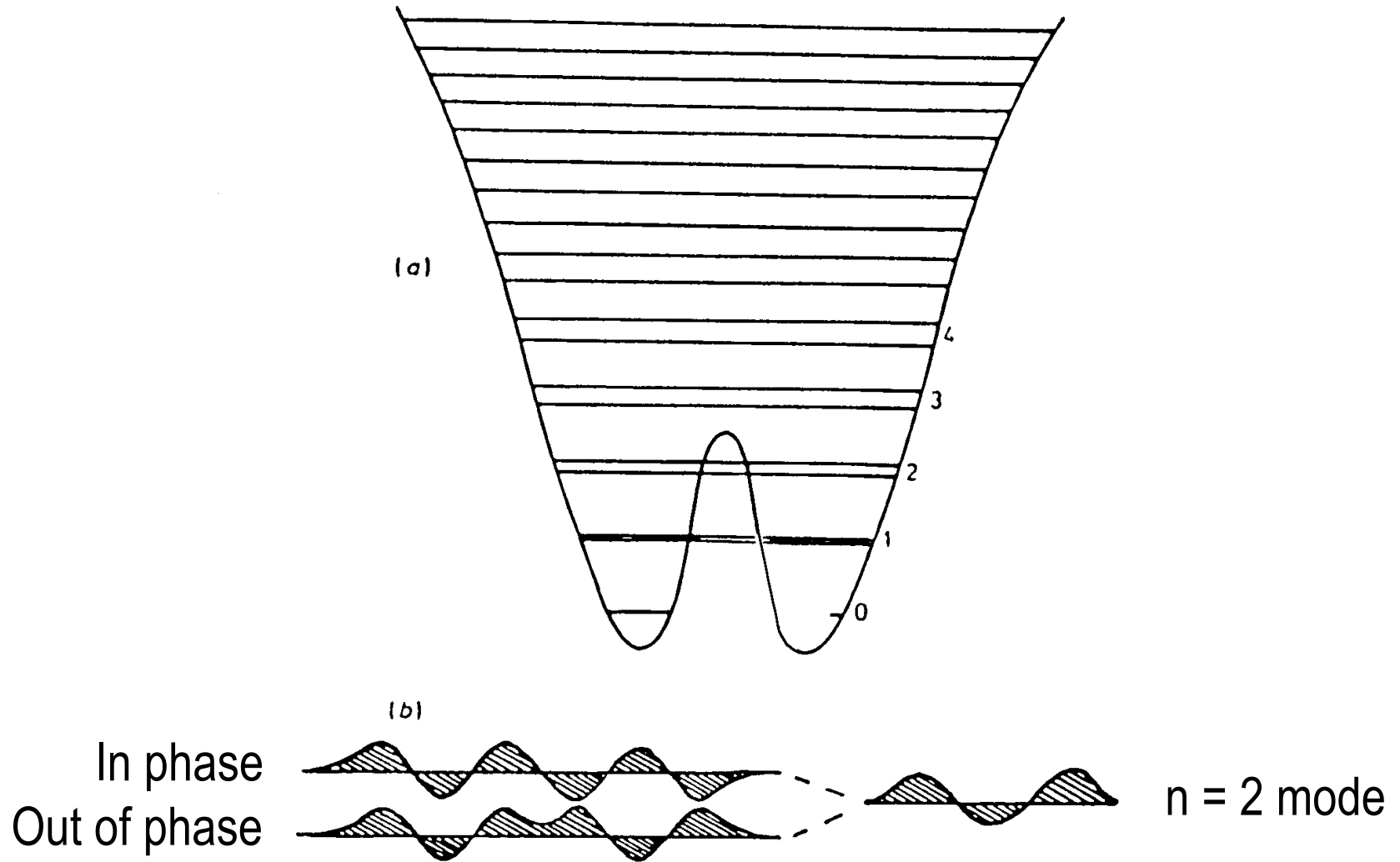

Figure 32.1. (a) Potential energy curve in the presence of an inversion mode of vibration. (b) On the right-hand side is drawn the $n = 2$ vibrational mode, and on the left-hand side a pair of the same modes have interacted in-phase and out-of-phase. Interaction takes place rear and above the central barrier to inversion.

No interaction when $n = 0$. At high amplitudes the wavefunctions mix either in phase or out of phase. A pair produces two independent functions which are non degenerate.

H_2S , H_2O $3a_1$ linear, H_2Se , H_2Te
 887 cm^{-1} Vs 1595 cm^{-1}

NH_3 , PH_3 , AsH_3 , SbH_3

950 (NH_3) 992 (PH_3)489; 906 (AsH_3)452 ; 781 (SbH_3) 387

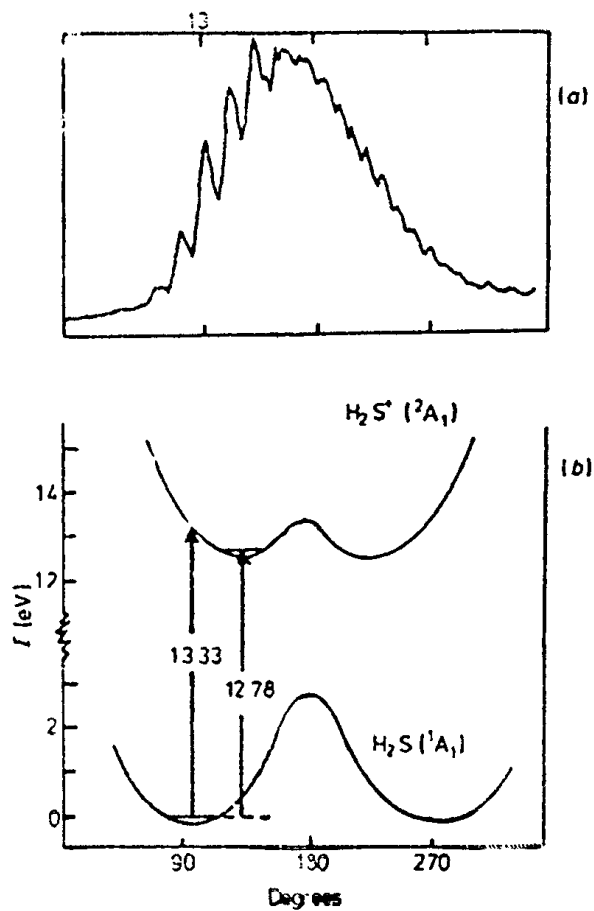
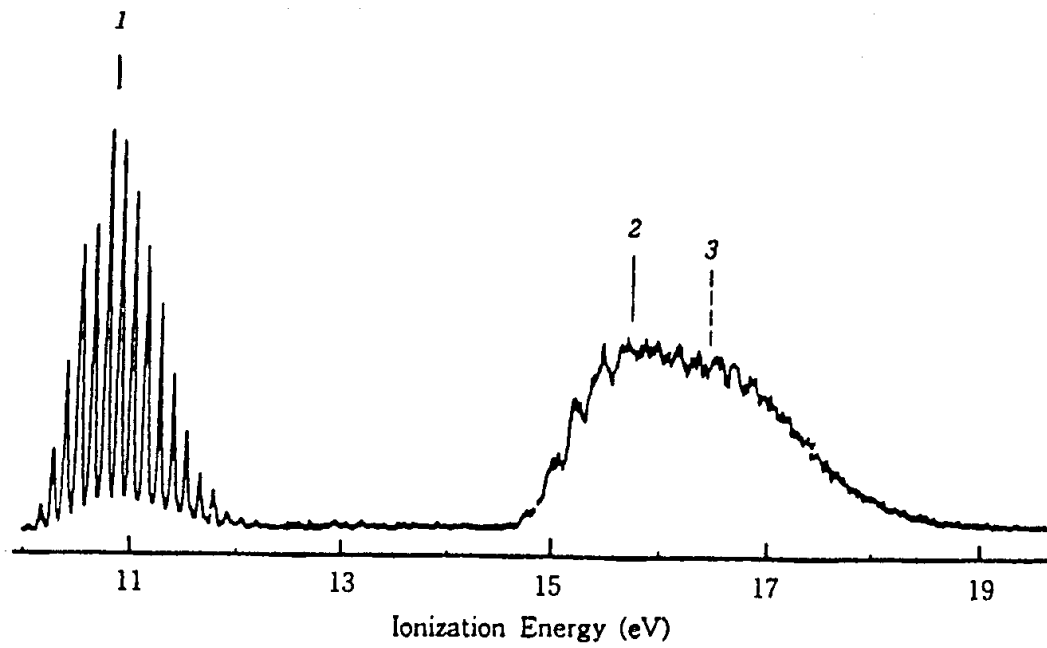

Figure 32.2. (a) The photoelectron spectrum of H_2S in the region of ionisation of the $3a_1$ electronic orbital (cf figure 17.2). The inversion barrier is surmounted at 13.3 eV, where a halving of the vibrational interval is seen (Potts and Price 1972). (b) Schematic potential energy plot of the ground state of H_2S and the $3a_1^{-1}$ state of H_2S^+ . The adiabatic and vertical ionisation energies are shown.



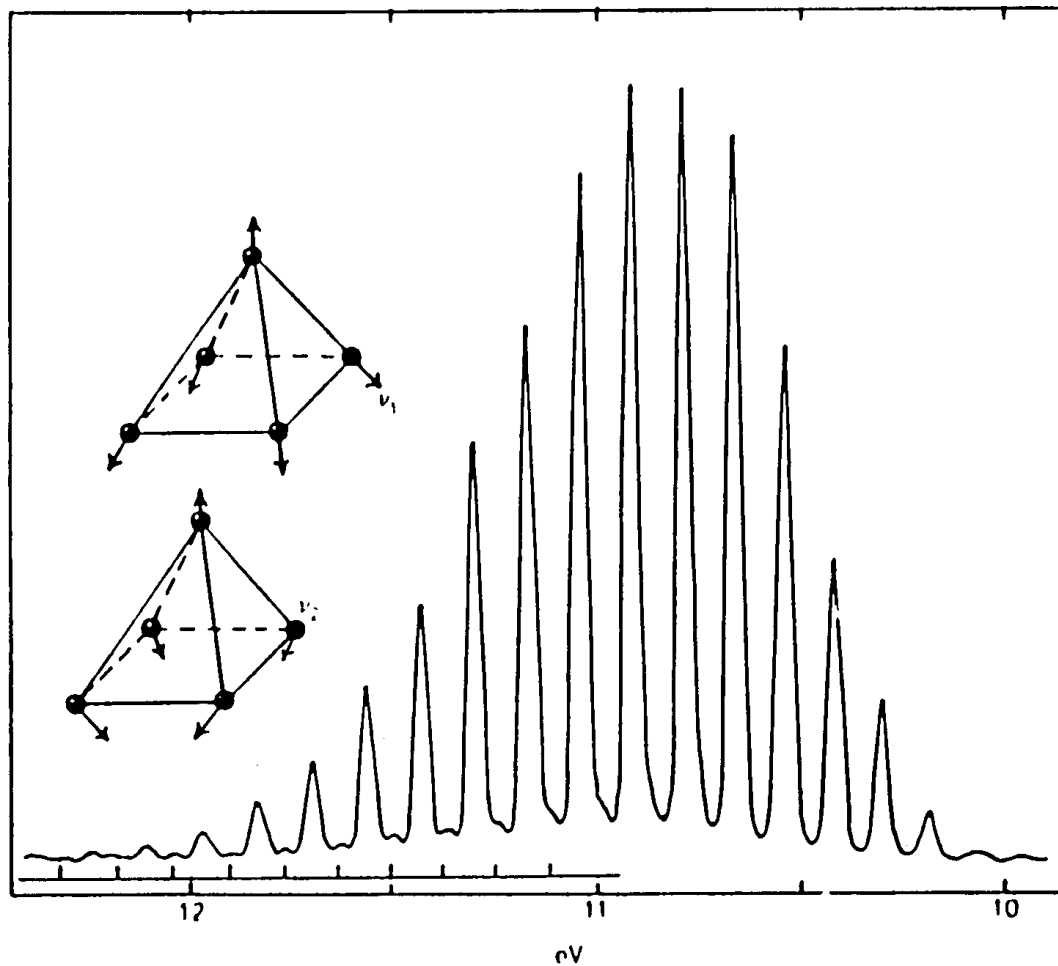
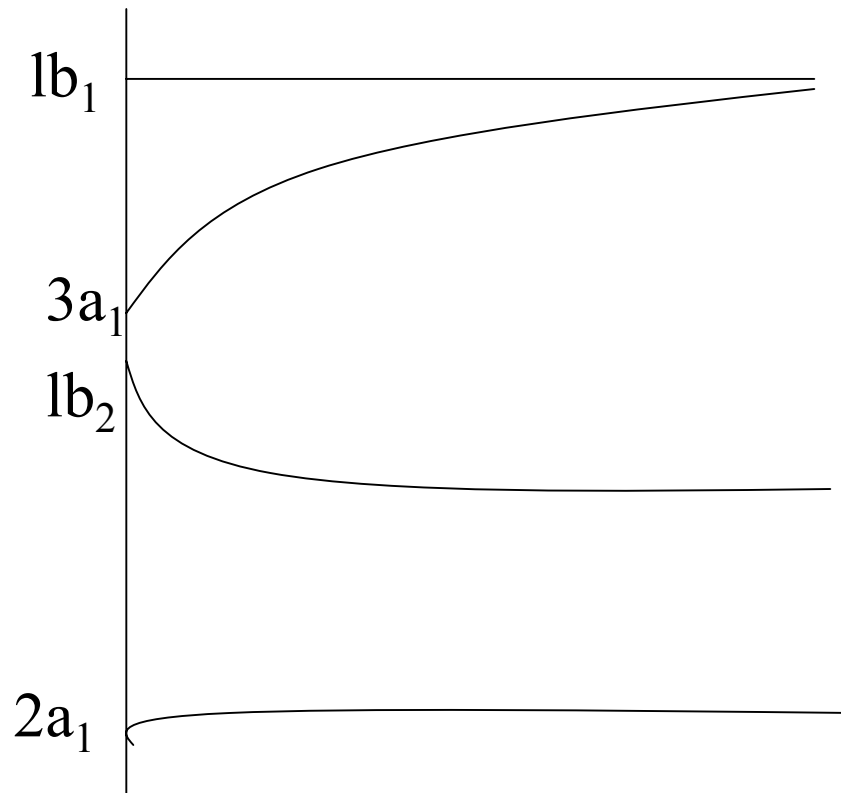

Figure 32.3. The photoelectron spectrum of ammonia in the region of ionisation of the $3a_1$ band (cf figure 17.2) showing two progressions of the inversion mode, ν_2 . The weaker of the two progressions is picked out by the vertical bars at the lower left of the figure; this probably arises from one quantum of ν_1 plus the ν_2 quanta (Rabalais *et al* 1972).

Jahn – Teller effect



Walsh diagram of water

Static and dynamic Jahn-Teller effects

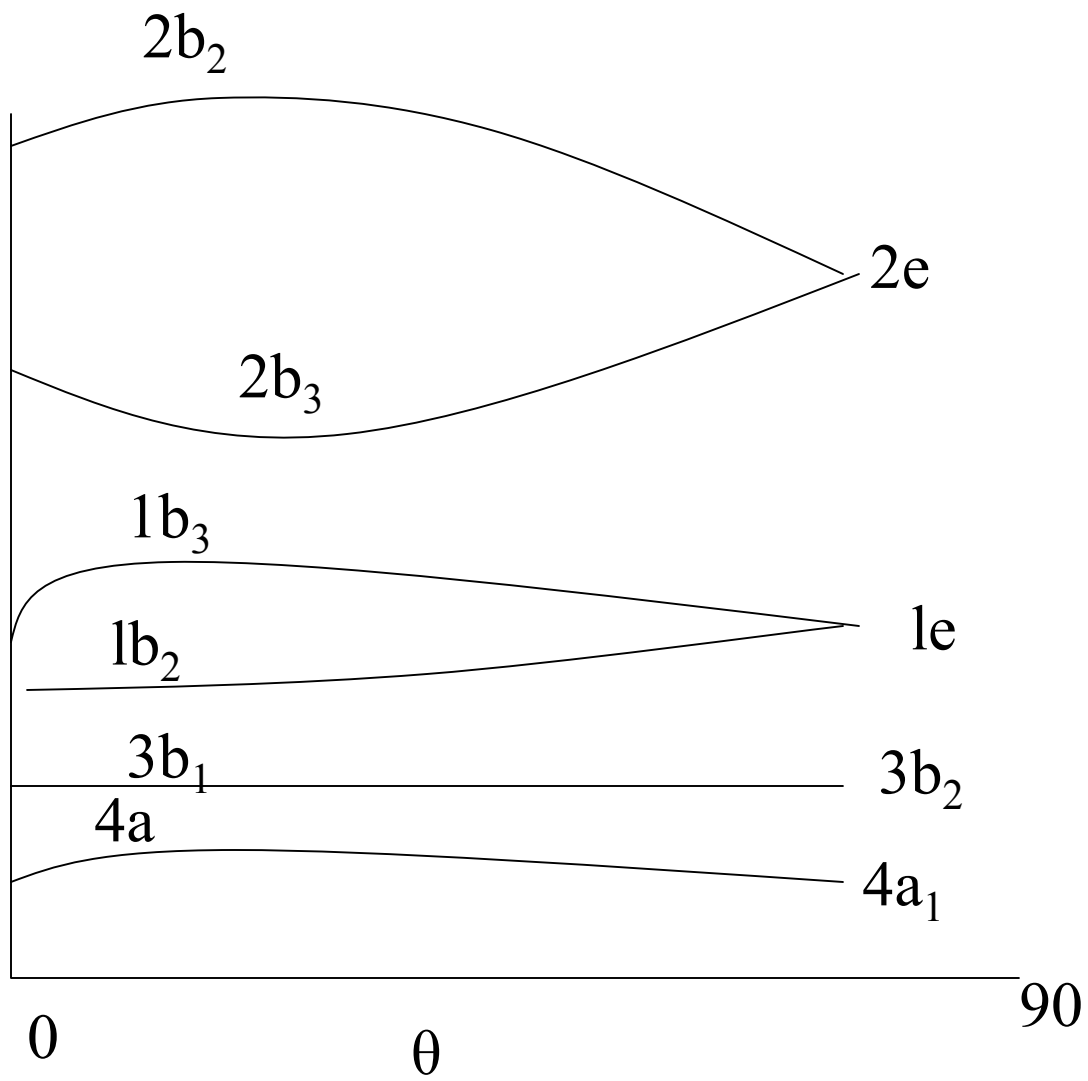

Allene

b_2 C – C – C asymmetric stretch $\rightarrow C_{2v}$
 b_1 torsional mode $\rightarrow D_2$ (except when $\theta = 0$
which makes it to D_{2h})

Jahn – Teller splitting of $2e \sim 0.6$ eV.

Which means θ to decrease by 12° .

Calculations indicate that $\theta = 38^\circ$ in the $2e^{-1}$ state

$1e$ splits only to a lesser extent

Jahn – Teller active vibrations

$$\langle \Psi_i | H_0 | \Psi_j \rangle = E_0 \text{ if } i = j$$

$$H = H_0 + v'Q + v'' Q^2 + \dots$$

Q = displacement vector

Q leads to new eigenfunctions.

$$\xi_j = \sum C_i \Psi_i$$

Neglecting higher order terms, this gives secular equations,

$$\begin{vmatrix} H_0 - E & v'Q \\ v'Q & H_0 - E \end{vmatrix} = 0$$

$$E = E_0 \pm \langle \Psi_1 | v'Q | \Psi_2 \rangle$$

If the second term is finite, the energy levels split. This will happen if the direct product of Ψ_1 and Ψ_2 contains an reducible representation as Q.

For the D_{2d} point group, (e x e) direct product gives A_1 , A_2 , B_1 and B_2 . Thus A_2 , B_2 and B_1 vibrations can be John-Teller active.

A_2 is not a pure vibration, it has rotational symmetry.

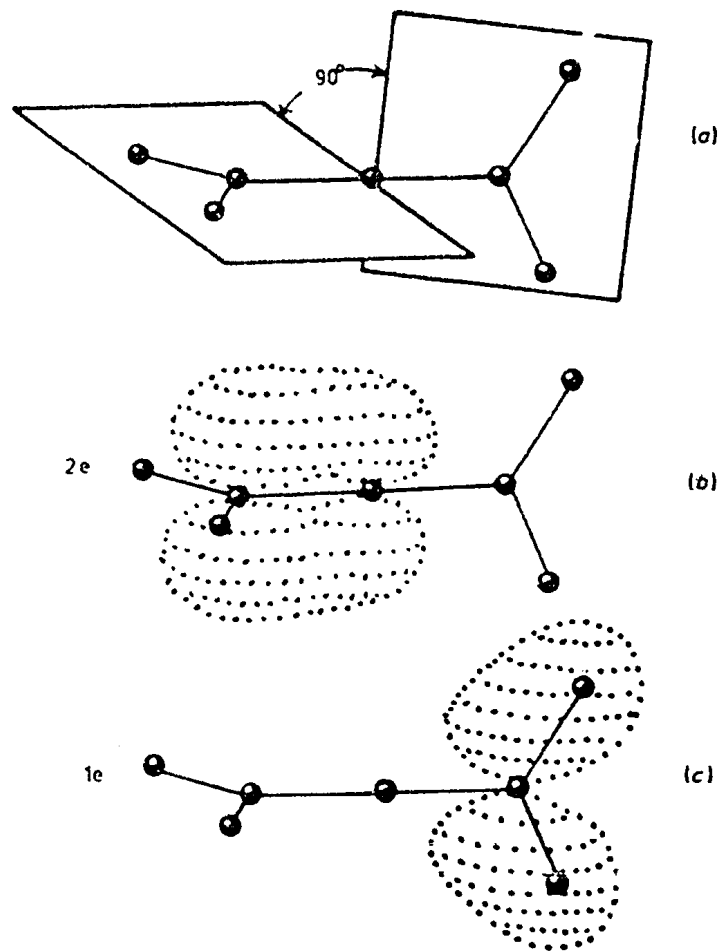

Figure 33.2. (a) The equilibrium geometry of allene. The C-C-C assembly is linear and the dihedral angle, θ , between the planes defined by the CH₂ groups is 90°. The point group is D_{2d} , and the x axis lies perpendicular to the C-C-C axis and bisects the dihedral angle. (b) and (c) Lobes of the molecular orbitals of e symmetry.

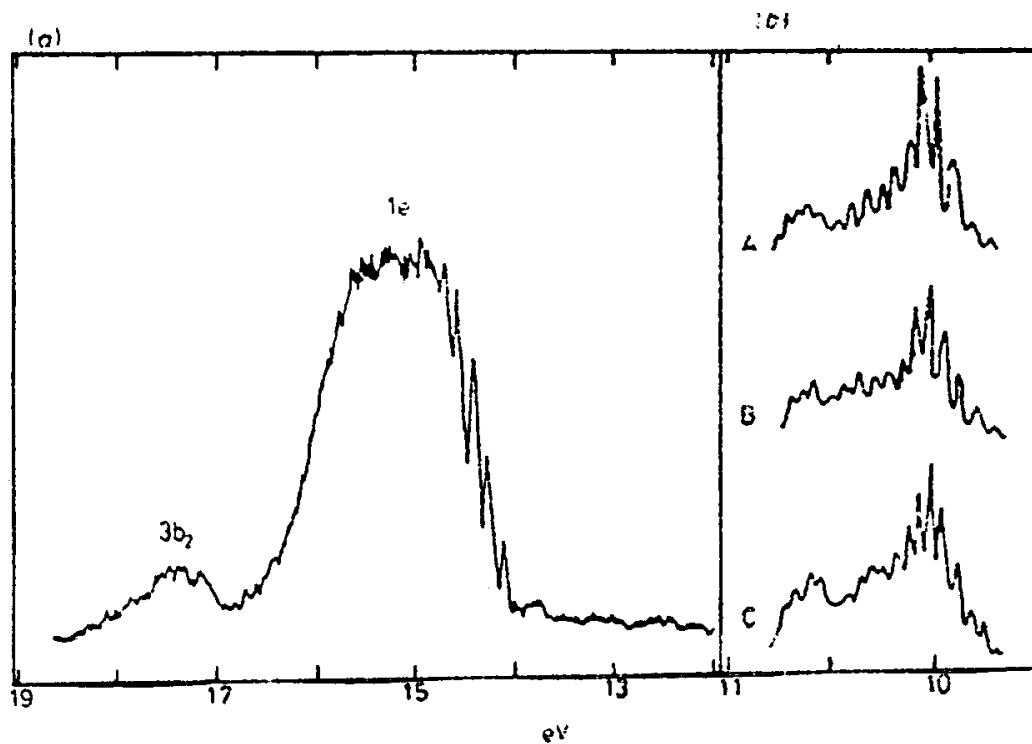
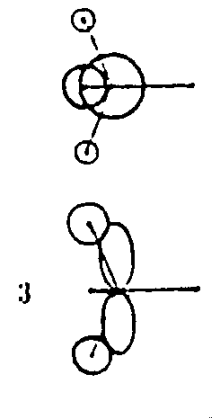
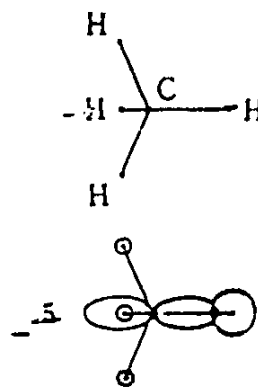
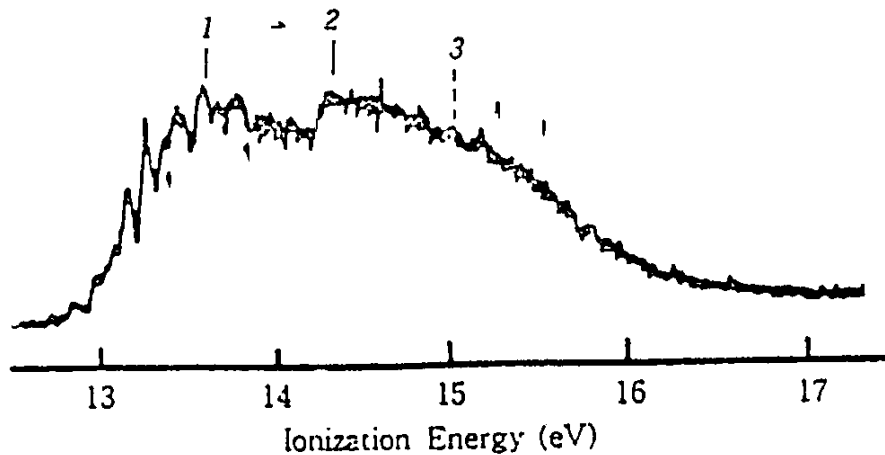
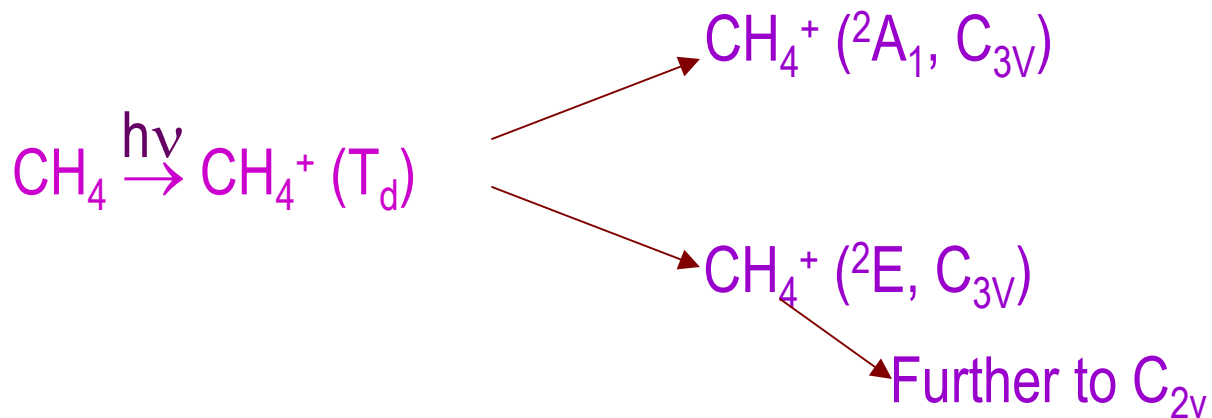

Figure 33.1. The photoelectron spectrum of allene. (a) The second and third bands (Turner *et al.* 1970). (b) The first bands of allene (curve A); allene-1,1-D₂ (curve B), and allene-D₄ (curve C) (Thomas and Thompson 1974). The first bands show evidence of the dynamic Jahn-Teller effect as there are two humps at 10.0 and 10.6 eV.



$1s_{a_1}^2 \ 2s_{a_1}^2 \ 2p_{t_2}^6$

$1A_1$



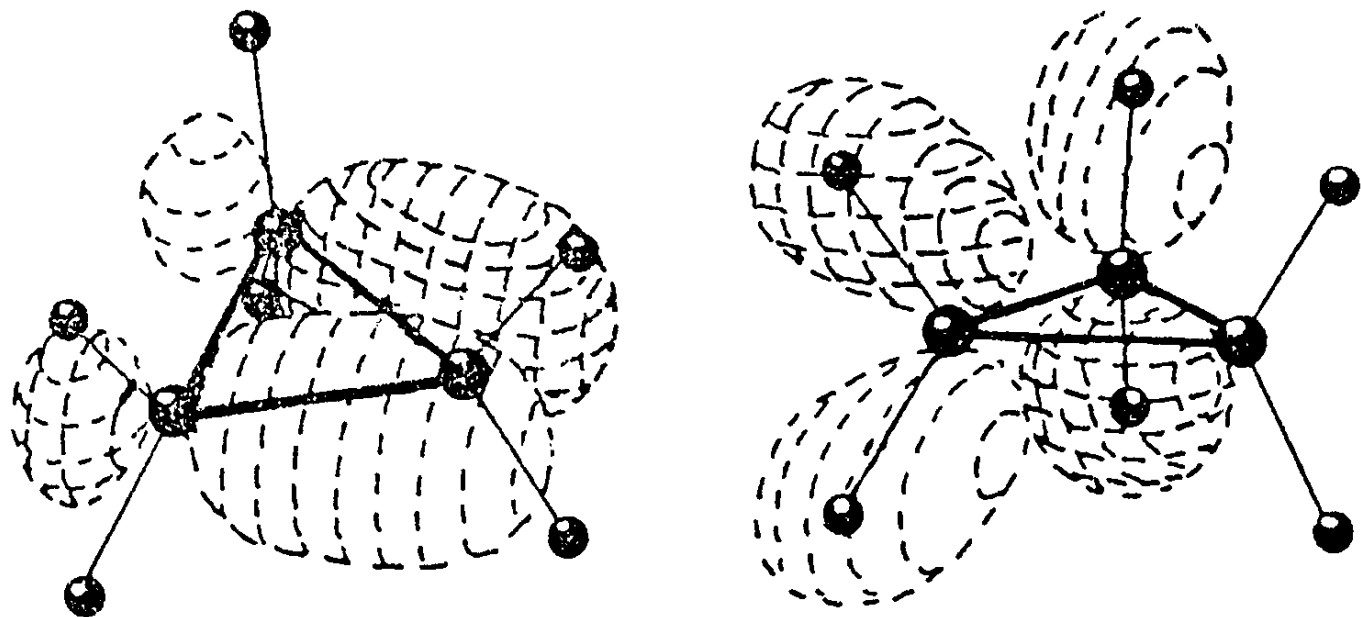

Figure 35.1. The upper occupied orbitals of cyclopropane. Doubly hatched lobes are of the opposite sign to those that are singly hatched.

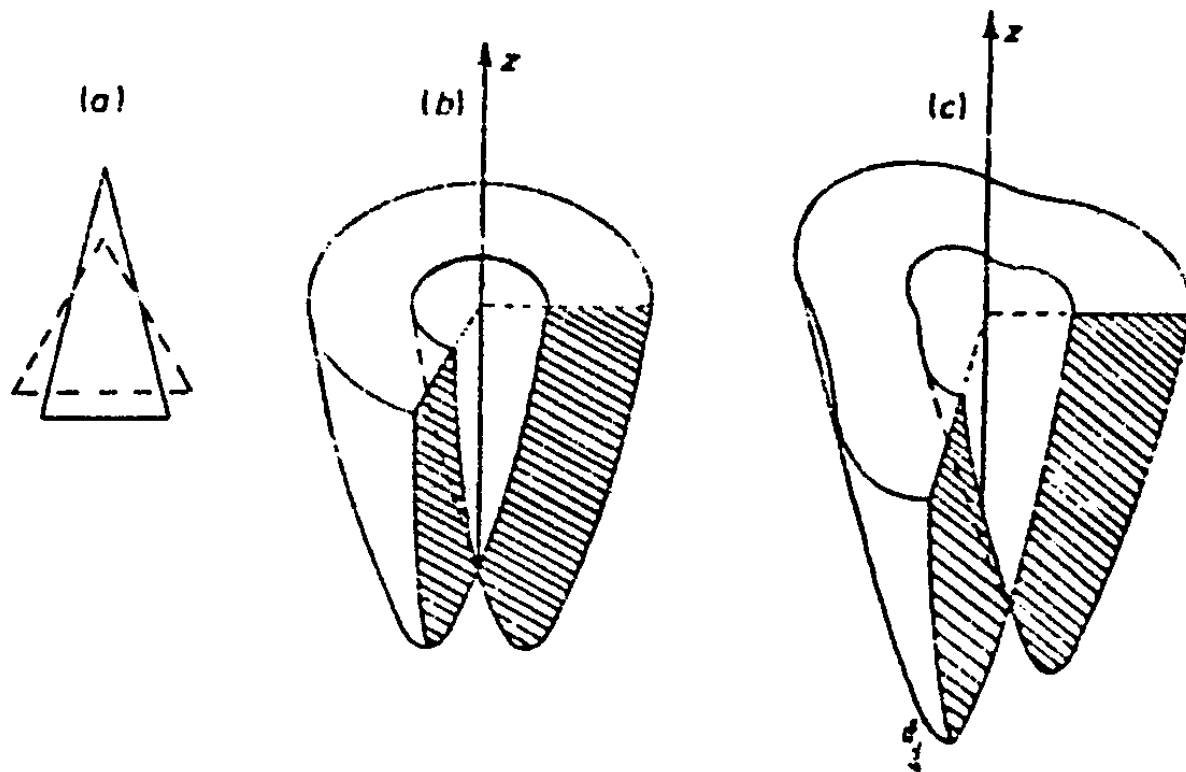

Figure 35.2. (a) e' vibrations produce the maximum Jahn-Teller splitting for the distortion from equilateral to isosceles geometry. (b) The axially symmetric energy surfaces obtained with equation (34.3) with the addition of a term for the Hooke's law energy, $\frac{1}{2}kQ^2$. Two surfaces are seen to become degenerate at the z axis. (c) Potential energy surfaces of trigonal symmetry obtained from equation (35.4) (Longuet-Higgins 1961).

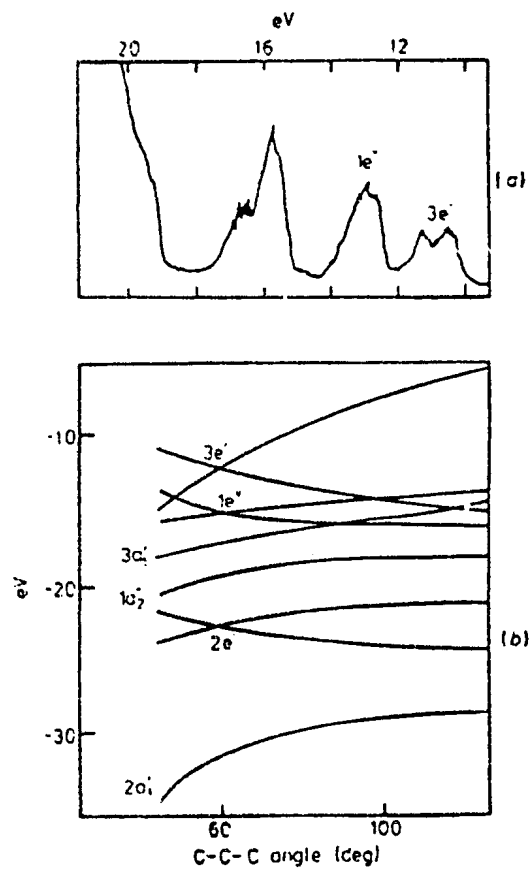
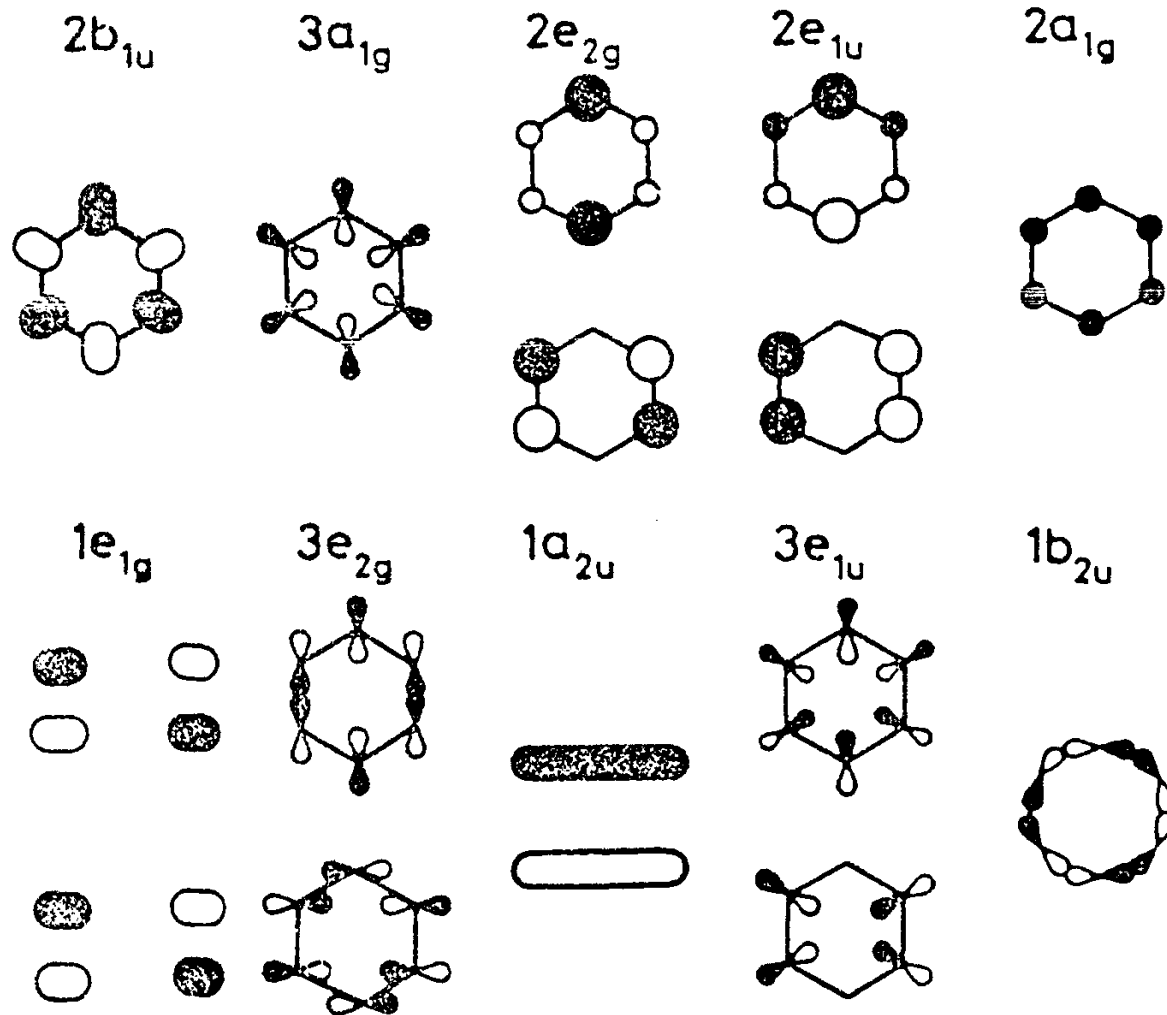
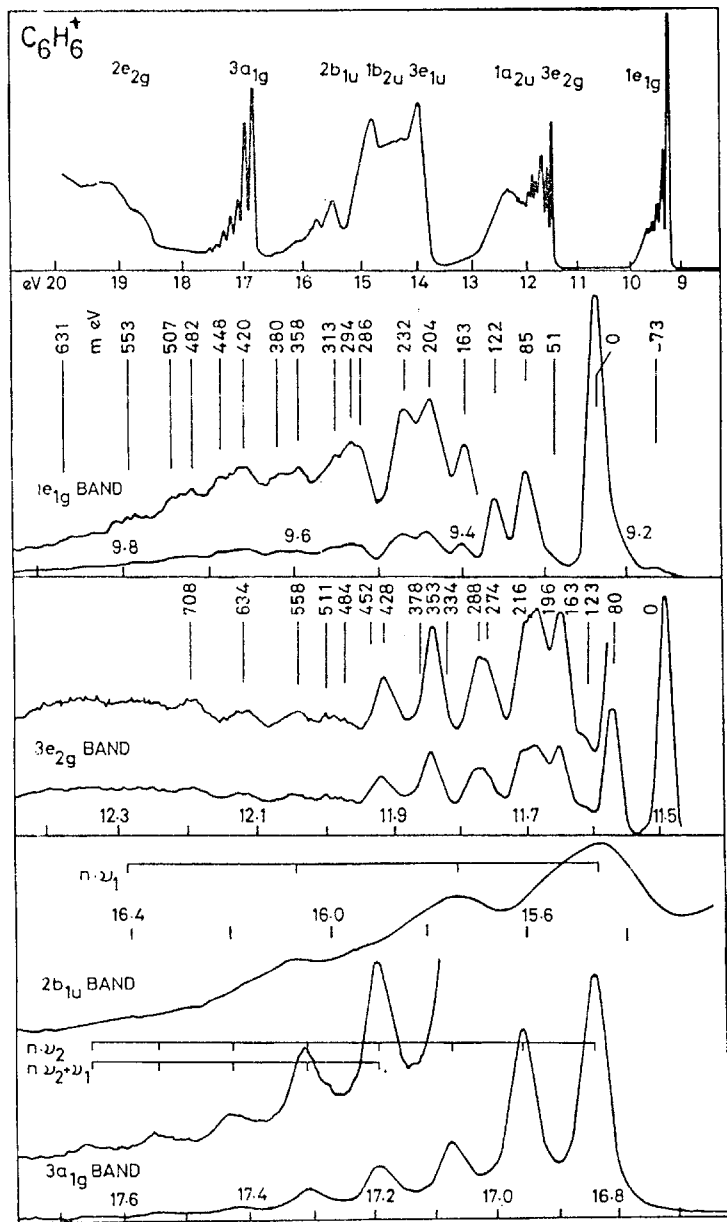

Figure 35.3. (a) The photoelectron spectrum of cyclopropane (gas phase) at 20-21 eV (Basch *et al* 1969). (b) Walsh diagram for cyclopropane (Buenker and Peyerimhoff 1974). The energy eigenvalues of the orbitals are plotted against the C-C-C angle.

Complex Molecules



PIPICO
MS – Fragmentation
Theory



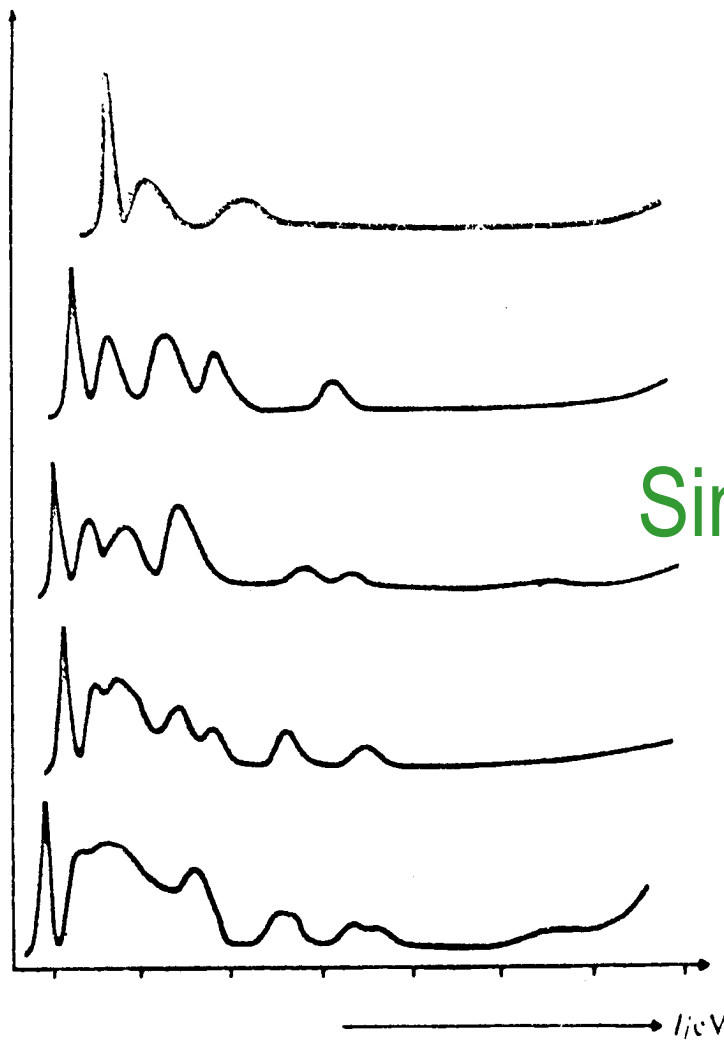

Simple empirical rules

Figure 20.56 He II PE spectra of H₂O and a number of alcohols and ethers.

Complex molecules

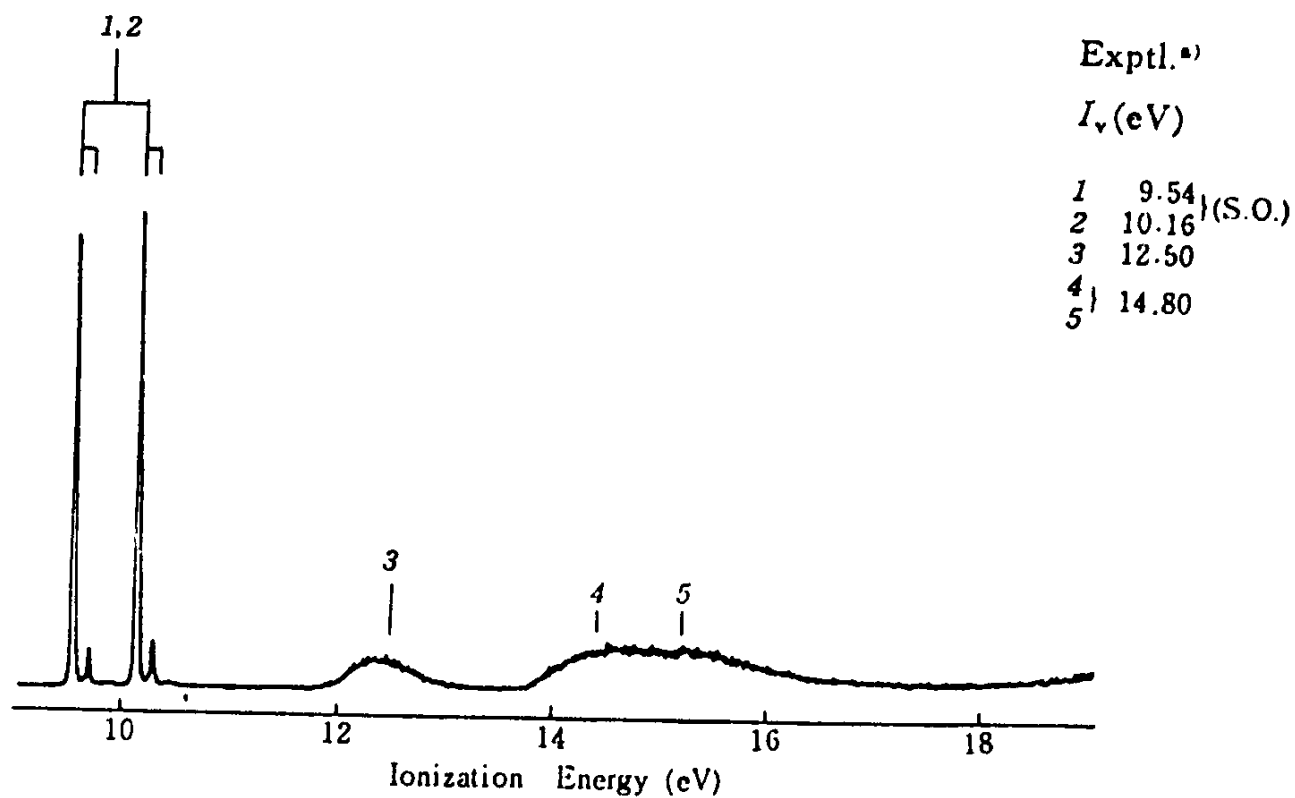

a) Kimura *et al.* (129a). See also other works: Potts *et al.* (176); Ragle *et al.* (192); Turner (213); Uehara *et al.* (216); and Dromey and Peel (86).

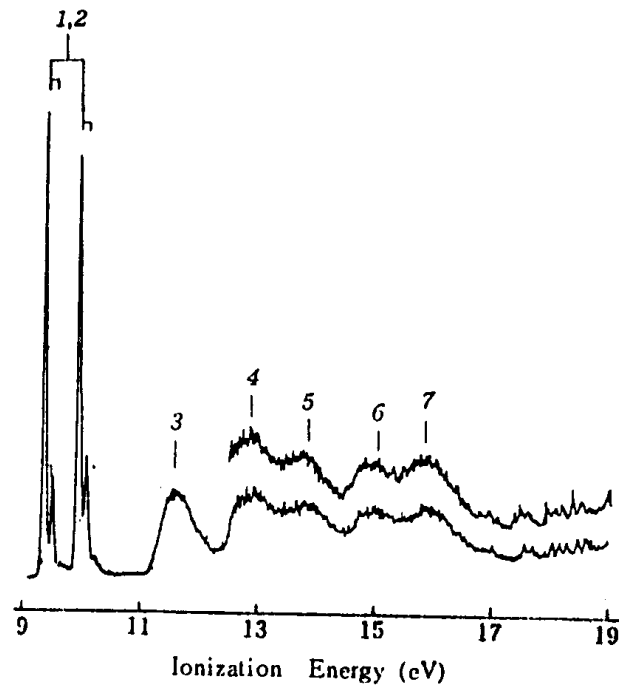

Exptl. ^{a)}	
I_v (eV)	
1	9.35
2	9.93
3	11.66
4	12.97
5	13.84
6	15.03
7	15.88

a) Kimura *et al.* (129a). See also other works: Dromey and Peel (86); Boschi and Salahub (34); Baker *et al.* (9); and Kimura *et al.* (129).

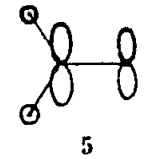
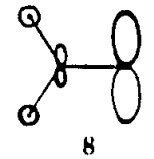
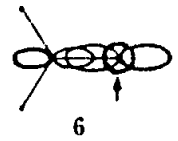
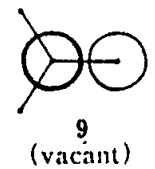
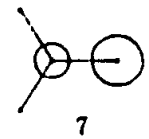
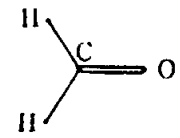
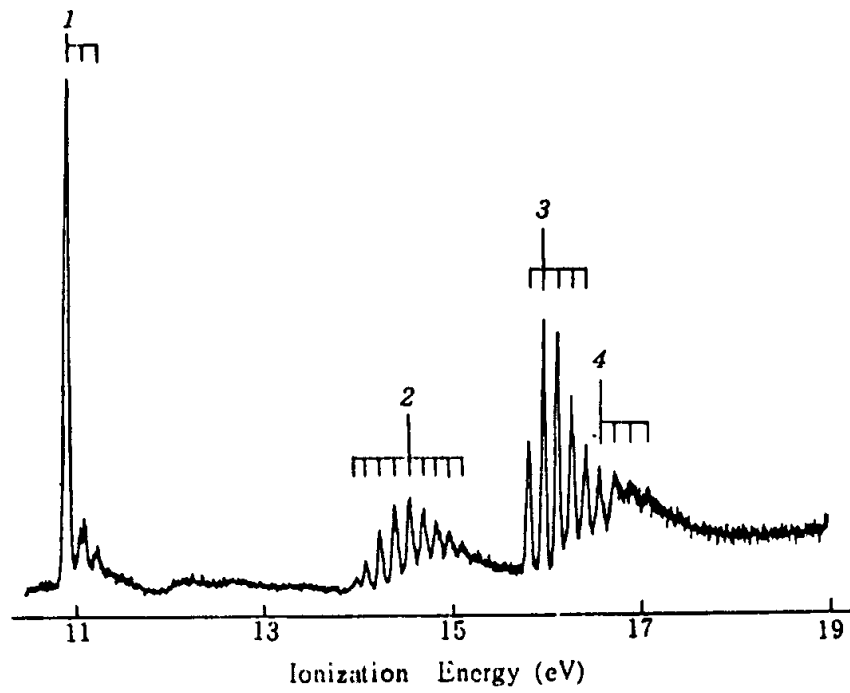

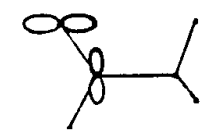
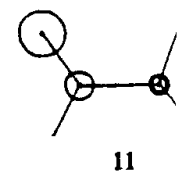
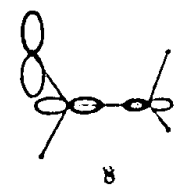
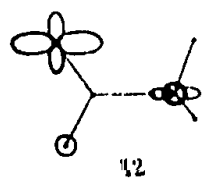
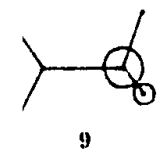
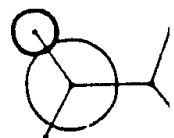
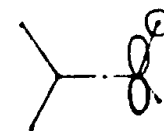
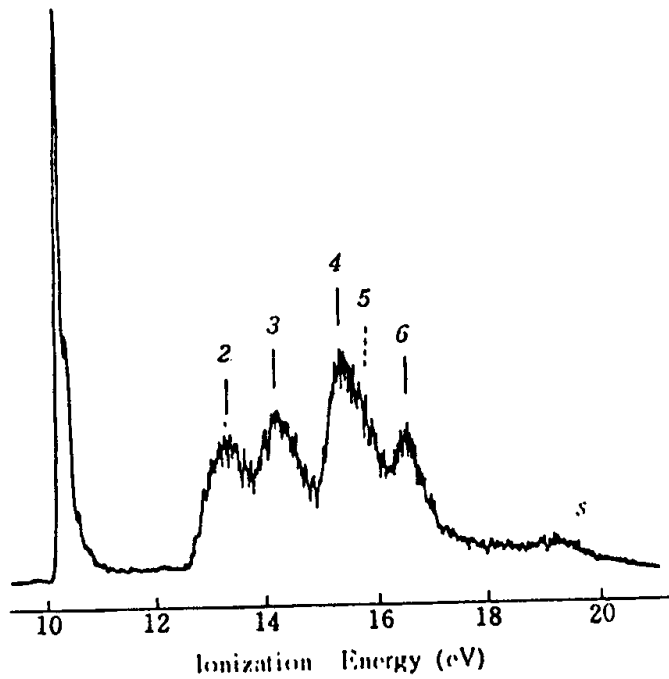

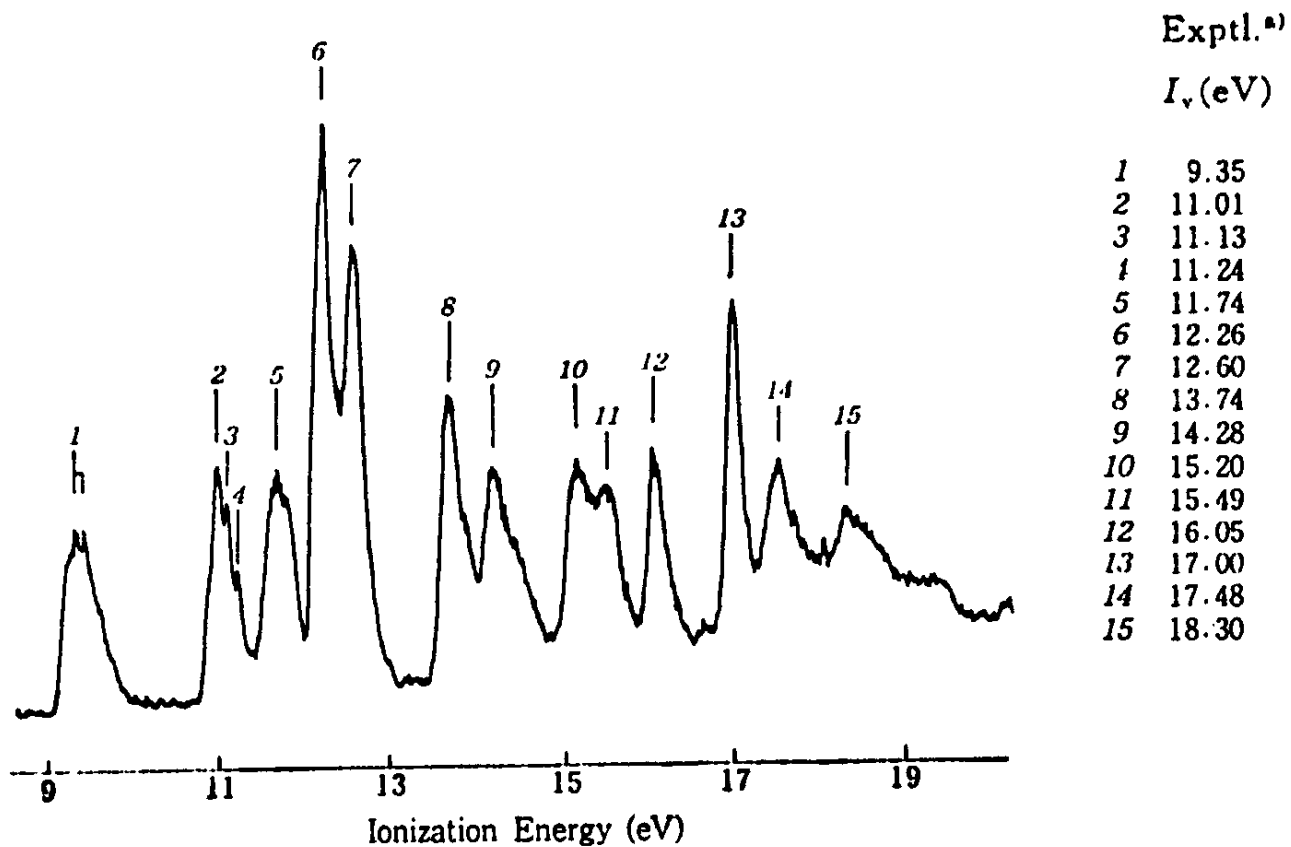

a) Kimura *et al.* (129a). See also other work : Streets and Ceasar (206).

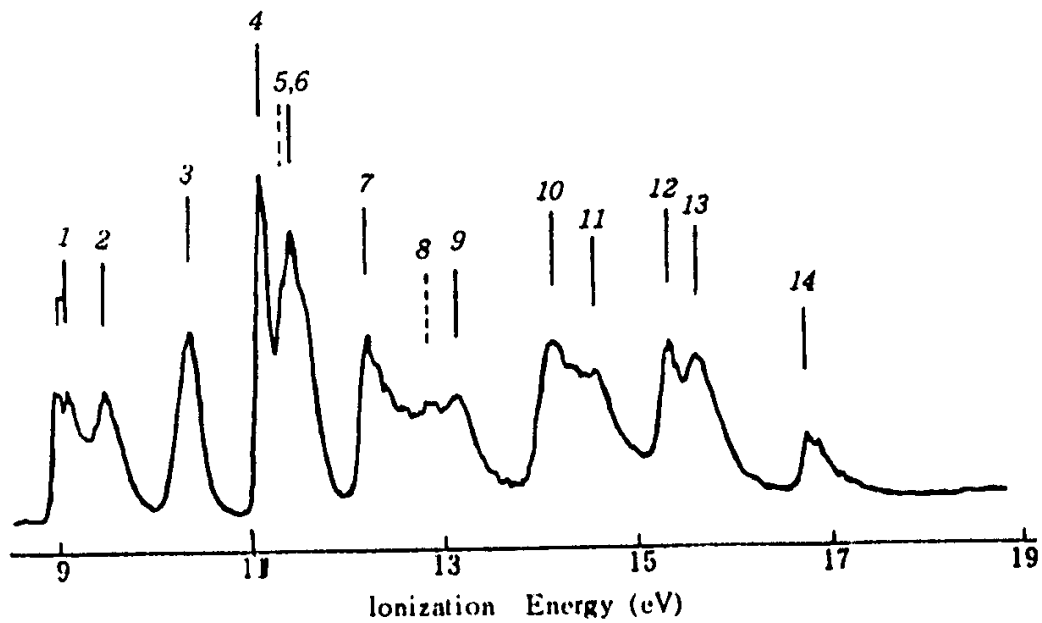
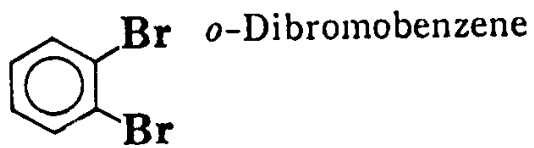

	Exptl. ^{a)}
	I_v (eV)
1	9.05
2	9.45
3	10.33
4	11.08
5	(11.3)
6	11.38
7	12.15
8	(12.8)
9	13.10
10	14.06
11	14.50
12	15.28
13	15.59
14	16.71

a) Kimura *et al.* (129a). See also other work : Streets and Ceasar (206).

(106) CH_3NH_2 Methylamine

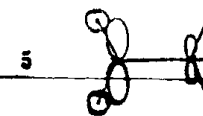
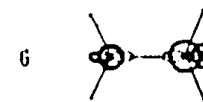
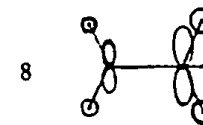
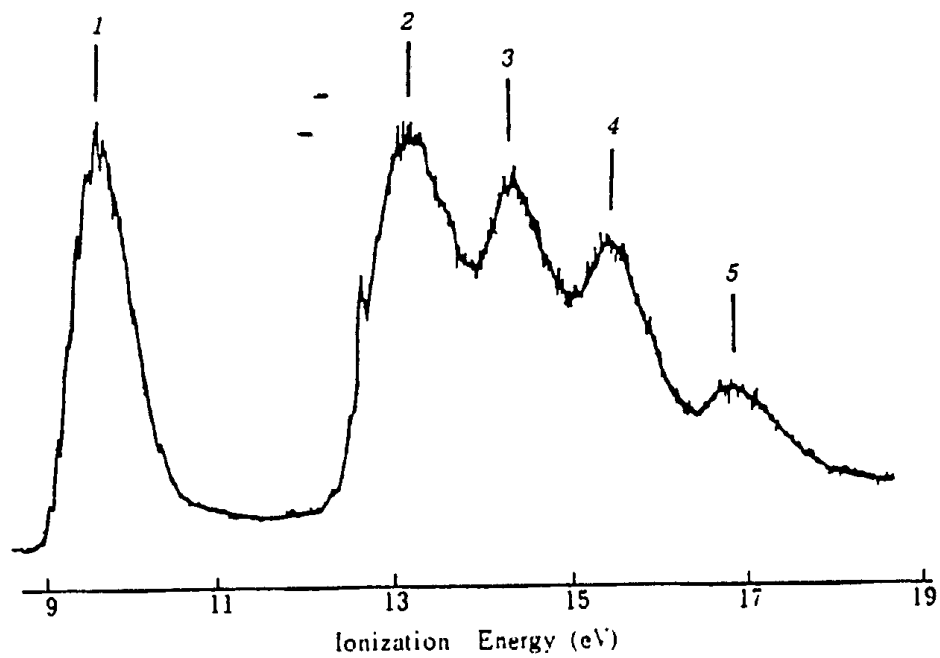
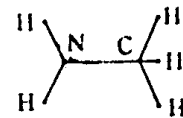

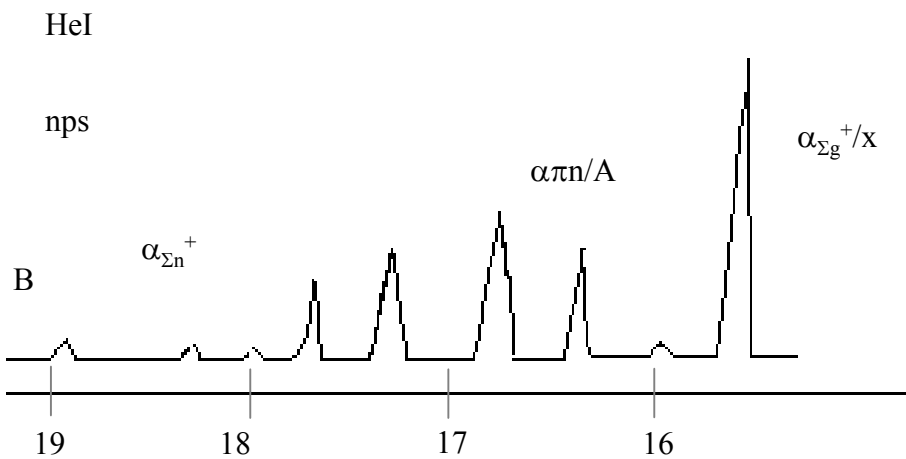
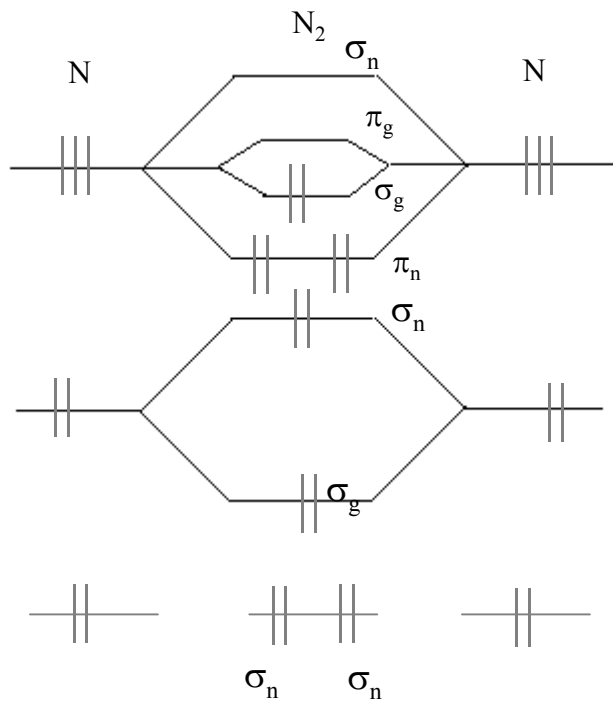

Mgk α

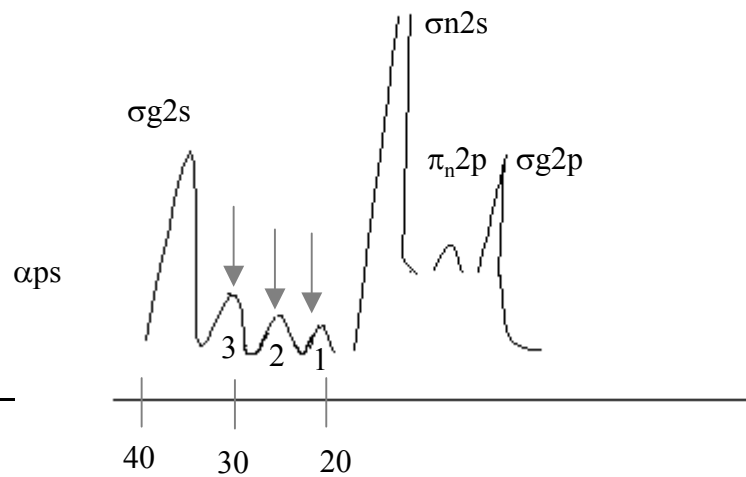

From an evaluation of molecular orbitals, it is possible to assign the photoelectron spectrum. Cross sections of orbitals vary substantially and therefore, intensities are different. Cross sections for 2s subshell is an order of magnitude larger than for 2p for Mg K_{α} . This is known from photoionization studies of Ne. Looking at the Mg K_{α} spectrum, it is seen that $\sigma_n 2s$ has largest 2s character. The 2s character is in the order $\sigma_u 2s > \sigma_g 2s > \sigma_g 2p$. $\pi_u 2p$ cannot have s character due to symmetry reasons.

$\sigma_g 2s$ is broad \rightarrow vibrational, Coster- Kronig.

Peaks marked by arrows are not due to direct photoemission.

1. shake-up of $\sigma_u 2s$
2. Mg $K_{\alpha_{3,4}}$
3. Energy loss of $\sigma_u 2s$.000